



INSURANCE COLLISION REPAIR CATALOG U.S. & CA

MARCH 2024



Quality Aftermarket Parts

Find a distributor near you at: peterbilt.com and TRPparts.com
Nationwide 1 Year Warranty • Distributed by PACCAR Parts



Quality Aftermarket Parts and Components

Welcome to the Peterbilt Insurance Collision Repair Catalog. Inside you will find a selection of repair parts that are commonly used in front end collisions. These parts will help reduce repair cost and provide an opportunity to retain resale value.

You will find a wide selection of grilles, hoods, bumpers, fenders, glass, fuel tanks and more. Each part is designed to either OE or Aftermarket standards and engineered for precision fit. Parts are stocked in conveniently located warehouses throughout the United States for quick delivery and reduced downtime. There are no hidden surprises in the pricing, and freight to the dealer location is included on product ordered from our network of distribution centers.

All products feature a full warranty backed by PACCAR Parts and a nationwide network of authorized retailers. For the retailer nearest you, visit www.peterbilt.com



CONTENTS



PETERBILT MODEL 357-378	4
PETERBILT MODEL 379	11
FREIGHTLINER CASCADIA	17
FREIGHTLINER COLUMBIA	23
FREIGHTLINER M2	26
INTERNATIONAL PROSTAR	29
VOLVO VNL	32
TRP ALL-MAKES GRILLES	39
TRP GRILLE GUARDS	40
TRP ALL-MAKES HOODS	41
TRP HOOD CABLES	46
TRP HOOD SPRINGS	47
PETERBILT AIR CLEANERS	48
TRP AIR CLEANERS	49
TRP FENDERS	50
TRP RADIATORS AND CHARGE AIR COOLERS	51
TRP METAL BUMPERS	53
TRP MIRRORS	54
TRP WINDSHIELDS	56
TRP WINDOW REGULATORS	64
TRP DOOR AND WINDOW HANDLES	65
TRP EXHAUST	68
PETERBILT FUEL TANKS	69
TRP FUEL TANKS	70
TRP FUEL TANK CAPS	74
TRP QUARTER FENDERS	75
TRP RUBBER COMPONENTS	76



GRILLE



PART NO.
RPG001

DESCRIPTION
GRILLE-HOOD 119"

OE CROSS REFERENCE
13-03507

GRILLE



PART NO.
RPGP002

DESCRIPTION
GRILLE - LEFT SIDE SHELL

OE CROSS REFERENCE
13-03962M001L-P

GRILLE



PART NO.
RPGP003

DESCRIPTION
GRILLE - RIGHT SIDE SHELL

OE CROSS REFERENCE
13-03962M001R-P

GRILLE



PART NO.
RPGP011

DESCRIPTION
GRILLE - LOWER MOLDING TRIM

OE CROSS REFERENCE
13-03529P

HOOD



PART NO.
AMHPB003-C

DESCRIPTION
PB 357 378 SFA 97&UP W/O
GRL ASSY

OE CROSS REFERENCE
13-04820A401

HOOD



PART NO.
AMHPB004-C

DESCRIPTION
PB 357 378 SFA 97&UP W/GRL
ASSY

OE CROSS REFERENCE
13-04820A401

HOOD



PART NO.
AMHPB007-C

DESCRIPTION
PB 379 ALUM 88-06 W/
FENDER

OE CROSS REFERENCE
13-03553, L29-6062 (MODEL
YEARS 88-06)

HOOD



PART NO.
RPHD002

DESCRIPTION
357/378 HOOD, 119" 2001-2007

OE CROSS REFERENCE
13-04821UNF

HOOD



PART NO.
RPHD004

DESCRIPTION
357/378 HOOD, 119" 2001-2004

OE CROSS REFERENCE
13-04811UNF

HOOD



PART NO.
RPHD005

DESCRIPTION
357/378 HOOD, 119" FEPTO

OE CROSS REFERENCE
13-04813UNF

HOOD SPRING



PART NO.
HS1369

DESCRIPTION
SPRING - HOOD TILT BLACK
379/378/377/386/385

OE CROSS REFERENCE
13-03569

HOOD SPRING



PART NO.
HS3046

DESCRIPTION
SPRING - HOOD BLUE-
PETERBILT 379/378/377/357

OE CROSS REFERENCE
13-03879, 13-04638

CHARGE AIR COOLER



PART NO.
CAC61-1024TRP

DESCRIPTION
CHARGE AIR COOLER,
PETERBILT 357, 378, 379

OE CROSS REFERENCE
1E3816

CHARGE AIR COOLER



PART NO.
CAC61-1553TRP

DESCRIPTION
CHARGE AIR COOLER,
PETERBILT 357, 378, 379

OE CROSS REFERENCE
ABPN09BH20B

RADIATOR

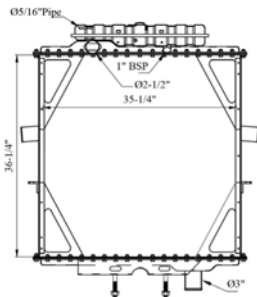

PART NO.
RAD42-10322TRP

DESCRIPTION
RADIATOR, PETERBILT 357,
375 SERIES

OE CROSS REFERENCE
0706657A011

RADIATOR



PART NO.
RAD42-10334TRP

DESCRIPTION
RADIATOR, PETERBILT 357,
375 SERIES

OE CROSS REFERENCE
BTC1102R

BUMPER

PART NO.
TX08C0020-02TS



DESCRIPTION
BUMPER-PB 378 & 379 CONV
16" TPR ROL END

OE CROSS REFERENCE
15-05435M001C, 15-
06485C2000

BUMPER

PART NO.
TX08C0020-06NP



The image shown is for illustration purposes only and may not be an exact representation of the product.

DESCRIPTION
BUMPER PB 378,379
CONV,18"TX,TOW,PALLET

OE CROSS REFERENCE
N/A

BUMPER

PART NO.
TX08C0020-06TS



DESCRIPTION
BUMPER-PB 378 & 379 CONV
18" SQ ROLL END

OE CROSS REFERENCE
15-06332-1H0C, N71-6011-21211

BUMPER

PART NO.
TX08C0020-11TS



DESCRIPTION
BUMPER-PB 378 & 379 CONV
18" SQ. BOX END

OE CROSS REFERENCE
N/A

BUMPER

PART NO.
TX08C0020-51NS



The image shown is for illustration purposes only and may not be an exact representation of the product.

DESCRIPTION
BUMPER PB 378,379
CONV,20"BOX,TOW

OE CROSS REFERENCE
N/A

BUMPER

PART NO.
TX08V0010-06TS



DESCRIPTION
BUMPER 18" 388,389,365 2007
& UP

OE CROSS REFERENCE
N71-6038-1001

HEADLAMP

PART NO.
16-07641L



DESCRIPTION
HEADLAMP ASSY-HALOGEN

OE CROSS REFERENCE
16-07641L

HEADLAMP

PART NO.
16-07641R



DESCRIPTION
HEADLAMP ASSY-HALOGEN

OE CROSS REFERENCE
16-07641R

MIRROR



PART NO.
EB50SS
DESCRIPTION
MIRROR
OE CROSS REFERENCE
708608, EB50S-S

MIRROR



PART NO.
MRKP01L
DESCRIPTION
MIRROR - BLACK LH,
DEFROST & TEMP SENSOR
OE CROSS REFERENCE
N/A

MIRROR



PART NO.
MRKP01R
DESCRIPTION
MIRROR - BLACK RH,
DEFROST
OE CROSS REFERENCE
N/A

MIRROR



PART NO.
TM915L
DESCRIPTION
MIRROR-FENDER MOUNT
OE CROSS REFERENCE
20-18590L

The image shown is for illustration purposes only and may not be an exact representation of the product.

MIRROR



PART NO.
TM915R
DESCRIPTION
MIRROR-FENDER MOUNT
RIGHT
OE CROSS REFERENCE
20-18590R

DOOR HANDLE



PART NO.
DRH021000L
DESCRIPTION
HANDLE-DOOR OUTSIDE LH
CHROME
OE CROSS REFERENCE
20-08179L

DOOR HANDLE



PART NO.
DRH021000R
DESCRIPTION
HANDLE-DOOR OUTSIDE RH
CHROME
OE CROSS REFERENCE
20-08179R

DOOR HANDLE



PART NO.
DRH021001L
DESCRIPTION
HANDLE-DOOR INSIDE LH
BLACK
OE CROSS REFERENCE
20-13412L

The image shown is for illustration purposes only and may not be an exact representation of the product.

DOOR HANDLE



PART NO.
DRH021001R

DESCRIPTION
HANDLE-DOOR INSIDE RH
BLACK

OE CROSS REFERENCE
20-13412R

DOOR HANDLE



PART NO.
DRH021002L

DESCRIPTION
HANDLE-DOOR BAG
OUTSIDE LH CHROME

OE CROSS REFERENCE
29-03610L

DOOR HANDLE

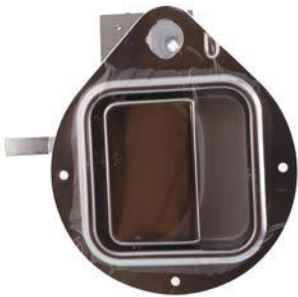

PART NO.
DRH021002R

DESCRIPTION
HANDLE-DOOR BAG
OUTSIDE RH CHROME

OE CROSS REFERENCE
29-03610R

DOOR HANDLE



PART NO.
DRH031000L

DESCRIPTION
HANDLE-DOOR OUTSIDE LH
BLACK HSG CHROME LEVER

OE CROSS REFERENCE
R56-1025L

DOOR HANDLE



PART NO.
DRH031000R

DESCRIPTION
HANDLE-DOOR OUTSIDE RH
BLACK HSG CHROME LEVER

OE CROSS REFERENCE
R56-1025R

WINDSHIELD

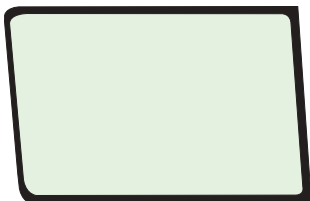

PART NO.	DESCRIPTION	OE CROSS REFERENCE	QTY
DW1036-10	GLASS-PETERBILT 10PK	20-14898R, R44-6022R	10
DW1036-30	GLASS-PETERBILT 30PK	20-14898R, R44-6022R	30

WINDSHIELD

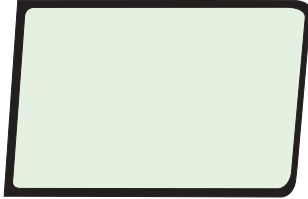

PART NO.	DESCRIPTION	OE CROSS REFERENCE	QTY
DW1037-10	GLASS-PETERBILT 10PK	20-14898L, R44-6022	10
DW1037-30	GLASS-PETERBILT 30PK	20-14898L, R44-6022	30



GRILLE



PART NO.
RPG001

DESCRIPTION
GRILLE 119"

OE CROSS REFERENCE
13-03507

GRILLE

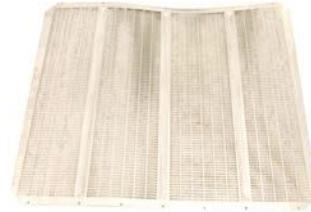

PART NO.
RPG003

DESCRIPTION
GRILLE 127"

OE CROSS REFERENCE
13-03508

GRILLE



PART NO.
RPGP006

DESCRIPTION
GRILLE - RIGHT SIDE SHELL
127"

OE CROSS REFERENCE
13-03964M001R-P

GRILLE



PART NO.
RPGP007

DESCRIPTION
GRILLE - LEFT SIDE SHELL
127"

OE CROSS REFERENCE
13-03964M001L-P

GRILLE



PART NO.
RPGP008

DESCRIPTION
GRILLE - RIGHT SIDE SHELL
119"

OE CROSS REFERENCE
13-03963M001R-P

GRILLE



PART NO.
RPGP009

DESCRIPTION
GRILLE - LEFT SIDE SHELL
119"

OE CROSS REFERENCE
13-03963M001L-P

GRILLE



PART NO.
RPGP010

DESCRIPTION
GRILLE BOTTOM SHELL 119"
& 127"

OE CROSS REFERENCE
13-03546P

GRILLE



PART NO.
RPGP011

DESCRIPTION
GRILLE LOWER MOLDING
119" & 127"

OE CROSS REFERENCE
13-03529P

GRILLE



The image shown is for illustration purposes only and may not be an exact representation of the product.

PART NO.
RPGP012

DESCRIPTION
GRILLE LOWER MOLDING
127"

OE CROSS REFERENCE
13-03531P

GRILLE



PART NO.
CR03508

DESCRIPTION
CROWN ASSY-STEEL

OE CROSS REFERENCE
N/A, NO OEM PART NUMBER
FOR COMPLETE SET

GRILLE



PART NO.
CR03513

DESCRIPTION
CROWN-HOOD 127" STEEL

OE CROSS REFERENCE
13-03515P

GRILLE GUARD



The image shown is for illustration purposes only and may not be an exact representation of the product.

PART NO.
TRPP202

DESCRIPTION
PB 379/567 GRILLE GUARD SS

OE CROSS REFERENCE

GRILLE GUARD



The image shown is for illustration purposes only and may not be an exact representation of the product.

PART NO.
TRPP202B

DESCRIPTION
PB 379/567 GRILLE GUARD
BLACK

OE CROSS REFERENCE

HOOD



PART NO.
AMHPB001-C

DESCRIPTION
PB 379 FBRGLS 88-06 W/
STNLS GRL

OE CROSS REFERENCE
13-03553, L29-6062 (MODEL
YEARS 88-06)

HOOD



PART NO.
AMHPB002-C

DESCRIPTION
PB 379 FBRGLS 88-06 W/GRL
& WIDE FNDR

OE CROSS REFERENCE
13-03553, L29-6062 (MODEL
YEARS 88-06 WITH WIDE LIP
FENDER)

HOOD



PART NO.
AMHPB007-C

DESCRIPTION
PB 379 ALUM 88-06 W/
FENDER

OE CROSS REFERENCE
13-03553, L29-6062 (MODEL
YEARS 88-06)

HOOD



PART NO.
AMHPB008-C

DESCRIPTION
PETER 379 FIBERGLASS
SHORT HOOD 88-06

OE CROSS REFERENCE
13-03552, L29-6061

HOOD SPRING



PART NO.
HS1309

DESCRIPTION
SPRING - HOOD RED
PETERBILT 389/379

OE CROSS REFERENCE
L81-6009

HOOD SPRING



PART NO.
HS1369

DESCRIPTION
SPRING - HOOD TILT BLACK
379/378/377/386/385

OE CROSS REFERENCE
13-03569

HOOD SPRING



PART NO.
HS3046

DESCRIPTION
SPRING - HOOD BLUE-
PETERBILT 379/378/377/357

OE CROSS REFERENCE
13-03879, 13-04638

FENDER



PART NO.
FN4905L

DESCRIPTION
ALUMINUM FENDER LEFT
HAND

OE CROSS REFERENCE
15-04905M001L,
15-04905M002L

FENDER



PART NO.
FN4905R

DESCRIPTION
ALUMINUM FENDER RIGHT
HAND

OE CROSS REFERENCE
15-04905M001R,
15-04905M002R

CHARGE AIR COOLER



PART NO.
CAC61-1024TRP

DESCRIPTION
CHARGE AIR COOLER,
PETERBILT 357, 378, 379

OE CROSS REFERENCE
IE3816

CHARGE AIR COOLER



PART NO.
CAC61-1553TRP

DESCRIPTION
CHARGE AIR COOLER,
PETERBILT 357, 378, 379
BAR&PLATE

OE CROSS REFERENCE
ABPN09BH20B

BUMPER

PART NO.
TX08C0020-02TS

DESCRIPTION
BUMPER-PB 378 & 379 CONV
16" TPR ROL END

OE CROSS REFERENCE
15-05435M001C, 15-06485C2000



BUMPER

PART NO.
TX08C0020-06NP

DESCRIPTION
BUMPER PB 378,379
CONV,18"TX,TOW,PALLET

OE CROSS REFERENCE
N/A



The image shown is for illustration purposes only and may not be an exact representation of the product.

BUMPER

PART NO.
TX08C0020-06TS

DESCRIPTION
BUMPER-PB 378 & 379 CONV
18" SQ ROLL END

OE CROSS REFERENCE
15-06332-1H0C, N71-6011-21211



BUMPER

PART NO.
TX08C0020-11TS

DESCRIPTION
BUMPER-PB 378 & 379 CONV
18" SQ. BOX END

OE CROSS REFERENCE
N/A



BUMPER

PART NO.
TX08C0020-51NS

DESCRIPTION
BUMPER PB 378,379
CONV,20"BOX,TOW

OE CROSS REFERENCE
N/A



The image shown is for illustration purposes only and may not be an exact representation of the product.

DOOR HANDLE

PART NO.
DRH021000L

DESCRIPTION
HANDLE-DOOR OUTSIDE LH
CHROME

OE CROSS REFERENCE
20-08179L



DOOR HANDLE

PART NO.
DRH021000R

DESCRIPTION
HANDLE-DOOR OUTSIDE RH
CHROME

OE CROSS REFERENCE
20-08179R



DOOR HANDLE

PART NO.
DRH021001L

DESCRIPTION
HANDLE-DOOR INSIDE LH
BLACK

OE CROSS REFERENCE
20-13412L



DOOR HANDLE



PART NO.
DRH021001R

DESCRIPTION
HANDLE-DOOR INSIDE RH
BLACK

OE CROSS REFERENCE
20-13412R

The image shown is for illustration purposes only and may not be an exact representation of the product.

WINDSHIELD



PART NO.	DESCRIPTION	OE CROSS REFERENCE	QTY
DW1036-10	GLASS-PETERBILT 10PK	20-14898R, R44-6022R	10
DW1036-30	GLASS-PETERBILT 30PK	20-14898R, R44-6022R	30

WINDSHIELD



PART NO.	DESCRIPTION	OE CROSS REFERENCE	QTY
DW1037-10	GLASS-PETERBILT 10PK	20-14898L, R44-6022	10
DW1037-30	GLASS-PETERBILT 30PK	20-14898L, R44-6022	30

FREIGHTLINER CASCADIA



GRILLE



PART NO.
GRFLCAS08

DESCRIPTION
GRILLE CASCADIA W/ BUGSCREEN,
2008-2018

OE CROSS REFERENCE
A17-19112-016, A1715624000,
A1715624002, A1719112000,
A1719112007, A1719933000,
A1719112011

GRILLE



PART NO.
GRFLCAS18

DESCRIPTION
GRILLE-FL CASCADIA CA 126 W/
BUG SCR

OE CROSS REFERENCE
A17-20832-013

GRILLE



PART NO.
GRFLCAS18BLK

DESCRIPTION
GRILLE-FL CASCADIA CA 126 W/
BUG SCR BLK

OE CROSS REFERENCE
A17-20832-009

GRILLE GUARD



PART NO.
TRPF201

DESCRIPTION
CASCADIA GRILLE GUARD '04-'17 T

OE CROSS REFERENCE
N/A

The image shown is for illustration purposes only and may not be an exact representation of the product.

GRILLE GUARD



PART NO.
TRPF201B

DESCRIPTION
CASCADIA GRILLE GUARD

OE CROSS REFERENCE
N/A

The image shown is for illustration purposes only and may not be an exact representation of the product.

GRILLE GUARD



PART NO.
TRPF202

DESCRIPTION
CASCADIA GRILLE GUARD '18 UP

OE CROSS REFERENCE
N/A

The image shown is for illustration purposes only and may not be an exact representation of the product.

GRILLE GUARD



PART NO.
TRPF202B

DESCRIPTION
CASCADIA GRILLE GUARD

OE CROSS REFERENCE
N/A

The image shown is for illustration purposes only and may not be an exact representation of the product.

GRILLE GUARD



PART NO.
TRPW202

DESCRIPTION
5700 CAS GRILLE GUARD '16 UP

OE CROSS REFERENCE
N/A

The image shown is for illustration purposes only and may not be an exact representation of the product.

HOOD



PART NO.
AMHFL012-C

DESCRIPTION
CASCADIA 125 LONG HOOD, 2008-2018

OE CROSS REFERENCE
A17-1534-0007, A17-15340-010,
A17-15340-015

HOOD



PART NO.
AMHFL013-C

DESCRIPTION
CASCADIA 125 LONG HOOD W/
HINGE BAR, 2008-2018

OE CROSS REFERENCE
A17-1534-0007, A17-15340-010,
A17-15340-015

HOOD



PART NO.
AMHFL015-C

DESCRIPTION
FL CASCADIA CA 126 LONG 18&UP
W/HINGE BA

OE CROSS REFERENCE
A-1720392003

RADIATOR



PART NO.
RAD42-10482TRP

DESCRIPTION
RADIATOR-FL CASCADIA 08-17

OE CROSS REFERENCE
N/A

MIRROR



PART NO.
MRFL01L

DESCRIPTION
MIRROR, WITH DEFROST, BLACK,
LH

OE CROSS REFERENCE
A22-60713-002

MIRROR



PART NO.
MRFL01L-C

DESCRIPTION
MIRROR, WITH DEFROST, CHROME,
LH

OE CROSS REFERENCE
A22-60713-005

MIRROR



PART NO.
MRFL01R

DESCRIPTION
MIRROR, WITH DEFROST, BLACK,
RH

OE CROSS REFERENCE
A22-60713-001

MIRROR



PART NO.
MRFL01R-C

DESCRIPTION
MIRROR, WITH DEFROST, CHROME,
RH

OE CROSS REFERENCE
A22-60713-003

MIRROR



PART NO.
MRFL02L

DESCRIPTION
HOOD MIRROR, BLACK, LH

OE CROSS REFERENCE
A22-66565-000

MIRROR



PART NO.
MRFL02L-C

DESCRIPTION
HOOD MIRROR, CHROME, LH

OE CROSS REFERENCE
A22-66565-002

MIRROR



PART NO.
MRFL02R

DESCRIPTION
HOOD MIRROR, BLACK, RH

OE CROSS REFERENCE
A22-66565-001

MIRROR



PART NO.
MRFL02R-C

DESCRIPTION
HOOD MIRROR, CHROME, RH

OE CROSS REFERENCE
A22-66565-003

DOOR HANDLE



PART NO.
DRH041001L

DESCRIPTION
HANDLE-DOOR OUTSIDE CHROME
LH

OE CROSS REFERENCE
A18-42228-000

DOOR HANDLE



PART NO.
DRH041001R

DESCRIPTION
HANDLE-DOOR OUTSIDE CHROME
RH

OE CROSS REFERENCE
A18-42228-001

DOOR HANDLE



PART NO.
DRH041004L

DESCRIPTION
HANDLE-DOOR OUTSIDE BLACK LH

OE CROSS REFERENCE
A18-47729-002

DOOR HANDLE



PART NO.
DRH041004R

DESCRIPTION
HANDLE-DOOR OUTSIDE BLACK RH

OE CROSS REFERENCE
A18-47729-003



FREIGHTLINER CASCADIA

WINDSHIELD



PART NO.	DESCRIPTION	OE CROSS REFERENCE	QTY
DW1731-5	GLASS-FREIGHTLINER CASCADIA, 5PK	A18-59152-001	5
DW1731-30	GLASS-FREIGHTLINER CASCADIA, 30PK	A18-59152-001	30

WINDSHIELD

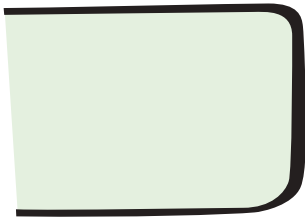

PART NO.	DESCRIPTION	OE CROSS REFERENCE	QTY
DW1732-5	GLASS-FREIGHTLINER CASCADIA, 5PK	A18-59152-000	5
DW1732-30	GLASS-FREIGHTLINER CASCADIA, 5PK	A18-59152-000	30

WINDSHIELD



PART NO.	DESCRIPTION	OE CROSS REFERENCE	QTY
DW2409-5	GLASS-FREIGHTLINER CASCADIA 5-PK LDWS	A18-67040-001, A18-67040-002	5
DW2409-20	GLASS-FREIGHTLINER CASCADIA 20-PK LDWS	A18-67040-001, A18-67040-002	20

WINDSHIELD



PART NO.	DESCRIPTION	OE CROSS REFERENCE	QTY
DW2419-5	GLASS-FREIGHTLINER CASCADIA 5-PK	A18-67040-001, A18-67040-002, A18-67040-006	5
DW2419-20	GLASS-FREIGHTLINER CASCADIA 20-PK	A18-67040-001, A18-67040-002, A18-67040-006	20

WINDSHIELD



PART NO.	DESCRIPTION	OE CROSS REFERENCE	QTY
DW2649-5	GLASS-FL CASCADIA 19 W/BRKT 5PK	A18-71102-000, A18-71102-000	5
DW2649-15	GLASS-FL CASCADIA 19 W/BRKT 15PK	A18-71102-000, A18-71102-000	15

FREIGHTLINER COLUMBIA



GRILLE



PART NO.
GRFLCOL0211

DESCRIPTION
GRILLE, CHROME W/BLACK

OE CROSS REFERENCE
A1715251001, A1715251002,
A1715251003, A1713590002,
A1713590004, A1713590006,
A1713590008, A1713590009,
A1713590010, A1713590011,
A1713590012

HOOD



PART NO.
AMHFLO03-C

DESCRIPTION
COLUMBIA CL120 HOOD, 2001-
2009

OE CROSS REFERENCE
A17-13575-001, A17-13575-005,
A17-15549-000, A17-15549-002,
A17-13575-006, A17-13575-007,
A17-16515-000, A17-16515-002,
A17-15064-001, A17-16953-000

HOOD



PART NO.
AMHFLO04-C

DESCRIPTION
COLUMBIA CL120 HOOD W/HINGE
BAR, 2001-2009

OE CROSS REFERENCE
A17-13575-001, A17-13575-005,
A17-15549-000, A17-15549-002,
A17-13575-006, A17-13575-007,
A17-16515-000, A17-16515-002,
A17-15064-001, A17-16953-000

CHARGE AIR COOLER



PART NO.
CAC61-1006TRP

DESCRIPTION
CHARGE AIR COOLER,
FREIGHTLINER COLUMBIA

OE CROSS REFERENCE
4863905001

CHARGE AIR COOLER



PART NO.
CAC61-1042TRP

DESCRIPTION
CHARGE AIR COOLER,
FREIGHTLINER COLUMBIA 2007+

OE CROSS REFERENCE
BHT59279

DOOR HANDLE



PART NO.
DRH041001L

DESCRIPTION
HANDLE-DOOR OUTSIDE CHROME
LH

OE CROSS REFERENCE
A18-42228-000

DOOR HANDLE



PART NO.
DRH041001R

DESCRIPTION
HANDLE-DOOR OUTSIDE CHROME
RH

OE CROSS REFERENCE
A18-42228-001

DOOR HANDLE



PART NO.
DRH041002L

DESCRIPTION
HANDLE-DOOR OUTSIDE CHROME
LH

OE CROSS REFERENCE
A18-42228-002



DOOR HANDLE



PART NO.
DRH041002R

DESCRIPTION
HANDLE-DOOR OUTSIDE CHROME
RH

OE CROSS REFERENCE
A18-42228-003

DOOR HANDLE



PART NO.
DRH041003L

DESCRIPTION
HANDLE-DOOR OUTSIDE W/O
30CM ROD BLACK LH

OE CROSS REFERENCE
A18-51913-008

DOOR HANDLE



PART NO.
DRH041003R

DESCRIPTION
HANDLE-DOOR OUTSIDE W/O
30CM ROD BLACK RH

OE CROSS REFERENCE
A18-51913-009

WINDSHIELD



PART NO.	DESCRIPTION	OE CROSS REFERENCE	QTY
DW1302-5	GLASS-FREIGHTLINER 5PK	18-32581-001, 18-46741-004	5
DW1302-30	GLASS-FREIGHTLINER 30PK	18-32581-001, 18-46741-004	30

WINDSHIELD

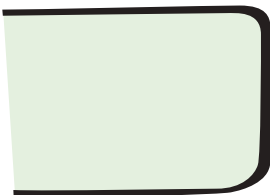

PART NO.	DESCRIPTION	OE CROSS REFERENCE	QTY
DW1303-5	GLASS-FREIGHTLINER 5PK	18-32581-000, 18-46741-003	5
DW1303-30	GLASS-FREIGHTLINER 30PK	18-32581-000, 18-46741-003	30

FREIGHTLINER M2



GRILLE



PART NO.
GRFLBCM2CR

DESCRIPTION
SURROUND, M2 112, CHROME W/
BUG SCREEN

OE CROSS REFERENCE
A17-15128-000, A1715685000

GRILLE



PART NO.
GRFLBCM2CRGR

DESCRIPTION
GRILLE, M2 112, CHROME W/BUG
SCREEN

OE CROSS REFERENCE
A17-14787-001, 1714104001,
1714787001

GRILLE



PART NO.
GRFLBCM2PA

DESCRIPTION
SURROUND, M2 112, PAINTED W/
BUG SCREEN

OE CROSS REFERENCE
A17-15128-001,
A1714518001, A1715128001,
A1715685001, 1715128020

GRILLE



PART NO.
GRFLBCM2PAGR

DESCRIPTION
GRILLE, M2 112, PAINTED W/BUG
SCREEN

OE CROSS REFERENCE
A17-14787-000, 1714104000,
1714787000

HOOD



PART NO.
AMHFLO14-C

DESCRIPTION
M2 112 HOOD 2003&UP

OE CROSS REFERENCE
A17-2001-3003

RADIATOR



PART NO.
RAD42-10359TRP

DESCRIPTION
RADIATOR-FL M2 03-07/ACTERRA
05-07

OE CROSS REFERENCE
BHTE2724, BHTE8278, BHTF1582,
BHTF2075

RADIATOR



PART NO.
RAD42-10523TRP

DESCRIPTION
RADIATOR-FL M2 08-10/L7500
08-10

OE CROSS REFERENCE
527409003

RADIATOR



PART NO.
RAD42-10545TRP

DESCRIPTION
RADIATOR-FREIGHTLINER M2
10-13

OE CROSS REFERENCE
BHTV9208001, BHTV9208002,
A0528847001

DOOR HANDLE



PART NO.
DRH041004L

DESCRIPTION
HANDLE-DOOR OUTSIDE BLACK LH

OE CROSS REFERENCE
A18-47729-002

DOOR HANDLE



PART NO.
DRH041004R

DESCRIPTION
HANDLE-DOOR OUTSIDE BLACK RH

OE CROSS REFERENCE
A18-47729-003

WINDSHIELD



PART NO.	DESCRIPTION	OE CROSS REFERENCE	QTY
DW1494-5	GLASS-FREIGHTLINER 5PK	A18-45300-003, A18-63440-000	5
DW1494-20	GLASS-FREIGHTLINER 20PK	A18-45300-003, A18-63440-000	20

INTERNATIONAL PROSTAR



GRILLE



PART NO.
GR1NTPR008

DESCRIPTION
GRILLE INTERNATIONAL PROSTAR -
CHROME W/BUG SCREEN, 2008-
2018

OE CROSS REFERENCE
2513238C1, 2604438C91,
2604438C93, 2604438C94,
2611271C92

GRILLE GUARD



PART NO.
TRPN201

DESCRIPTION
PROSTAR LT GRILLE GUARD '08 UP

OE CROSS REFERENCE
N/A

The image shown is for illustration purposes only and may not be an exact representation of the product.

GRILLE GUARD



PART NO.
TRPN201B

DESCRIPTION
PROSTAR LT GRILLE GUARD '08 UP
BLACK

OE CROSS REFERENCE
N/A

The image shown is for illustration purposes only and may not be an exact representation of the product.

HOOD



PART NO.
AMHNV018-C

DESCRIPTION
PROSTAR LONG 56" HOOD 2008-
2018

OE CROSS REFERENCE
3611066C97, 3858844C91,
3858844C92

HOOD



PART NO.
AMHNV019-C

DESCRIPTION
PROSTAR LONG 56" HOOD W/
HINGE BAR, 2008-2018

OE CROSS REFERENCE
3611066C97, 3858844C91,
3858844C92

RADIATOR



PART NO.
RAD42-10553TRP

DESCRIPTION
RADIATOR-NAVISTAR INTL PROSTAR
12-13

OE CROSS REFERENCE
2513238C1, 2604438C91,
2604438C93, 2604438C94,
2611271C92

RADIATOR



PART NO.
RAD42-10554TRP

DESCRIPTION
RADIATOR-NAVISTAR INTL PROSTAR
08-10

OE CROSS REFERENCE
2594850C91

BUMPER



PART NO.
TX0452011-18TF

DESCRIPTION
BUMPER INTL PROSTAR FIXED
MNT, FOG, CHROME

OE CROSS REFERENCE
6086846C95, 6086846C96



DOOR HANDLE



PART NO.
DRH051002R

DESCRIPTION
HANDLE-DOOR INSIDE RH BLACK

OE CROSS REFERENCE
2505425C1

DOOR HANDLE



PART NO.
DRH051002L

DESCRIPTION
HANDLE-DOOR INSIDE LH BLACK

OE CROSS REFERENCE
2505424C1

WINDSHIELD



PART NO.	DESCRIPTION	OE CROSS REFERENCE	QTY
DW1685-5	GLASS-NAVISTAR 06-10 5PK	3354252C4	5
DW1685-20	GLASS-NAVISTAR ECAP 06-10 20PK	3354252C4	20

WINDSHIELD



PART NO.	DESCRIPTION	OE CROSS REFERENCE	QTY
DW1765-5	GLASS-NAVISTAR ECAP 08-10 5PK - HEATED	3554252C4, 3554252C5, 3554252C6	5
DW1765-20	GLASS-NAVISTAR ECAP 08-10 20PK - HEATED	3554252C4, 3554252C5, 3554252C6	20

WINDSHIELD



PART NO.	DESCRIPTION	OE CROSS REFERENCE	QTY
DW2550-20	GLASS-NAVISTAR PROSTAR 2019 20PK	N/A	20

VOLVO VNL



GRILLE



PART NO.
GRV0LVNL

DESCRIPTION
GRILLE, CHROME W/BUG SCREEN,
1998-2003

OE CROSS REFERENCE
8084221

GRILLE



PART NO.
GRV0LVNL04

DESCRIPTION
GRILLE, CHROME W/BUG SCREEN,
2004-2018

OE CROSS REFERENCE
82733842

GRILLE GUARD



PART NO.
TRPV201

DESCRIPTION
VNL/VNR GRILLE GUARD '03-'16

OE CROSS REFERENCE
N/A

The image shown is for illustration purposes only and may not be an exact representation of the product.

GRILLE GUARD



PART NO.
TRPV202

DESCRIPTION
VNL/VNR GRILLE GUARD '18 UP

OE CROSS REFERENCE
N/A

The image shown is for illustration purposes only and may not be an exact representation of the product.

HOOD



PART NO.
AMHVLO01-C

DESCRIPTION
VNL HOOD 1998-2002

OE CROSS REFERENCE
20377848, 20377850, 20370861,
20377849, 20378059

HOOD



PART NO.
AMHVLO02-C

DESCRIPTION
VNL HOOD 2004&UP

OE CROSS REFERENCE
21113797, 21113794, 82718447,
82718448

RADIATOR

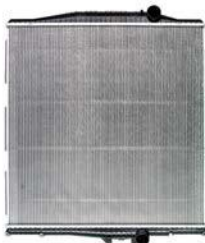

PART NO.
RAD42-10205TRP

DESCRIPTION
RADIATOR, VOLVO VNL 4200
SERIES

OE CROSS REFERENCE
126435

RADIATOR



PART NO.
RAD42-10289PDC

DESCRIPTION
RADIATOR-VOLVO MACK/VN
SERIES 08-15

OE CROSS REFERENCE
21146403, 21504536,
22644024, 85125539, 85148411

RADIATOR



PART NO.
RAD42-10289TRP

DESCRIPTION
RADIATOR-VOLVO MACK/VN
SERIES 08-15

OE CROSS REFERENCE
21146403, 21504536,
22644024, 85125539, 85148411

RADIATOR



PART NO.
RAD42-10308TRP

DESCRIPTION
RADIATOR-VOLVO VNL 08-10, VNM
08-10

OE CROSS REFERENCE
203004, 559198, 2400591,
20585504

RADIATOR



PART NO.
RADS10289TRP

DESCRIPTION
RADIATOR-VOLVO MACK/VN
SERIES 08-15

OE CROSS REFERENCE
21146403, 21504536,
22644024, 85125539, 85148411

MIRROR



PART NO.
MRVL01L

DESCRIPTION
MIRROR VL W/DEFROST BLACK LH

OE CROSS REFERENCE
82239803

MIRROR



PART NO.
MRVL01L-C

DESCRIPTION
MIRROR VL W/DEFROST CHROME
W/BLACK ARM L

OE CROSS REFERENCE
82239815 / 20701416

MIRROR



PART NO.
MRVL01R

DESCRIPTION
MIRROR VL W/DEFROST BLACK RH

OE CROSS REFERENCE
82239804

MIRROR



PART NO.
MRVL01R-C

DESCRIPTION
MIRROR VL W/DEFROST CHROME
W/BLACK ARM R

OE CROSS REFERENCE
82239816 / 20701418

MIRROR



PART NO.
MRVL02L

DESCRIPTION
MIRROR VL W/SIGNAL AND
DEFROST BLACK LH

OE CROSS REFERENCE
82715380

MIRROR



PART NO.
MRVL02L-C

DESCRIPTION
MIRROR VL W/SIGNAL AND
DEFROST CHR BLK A

OE CROSS REFERENCE
82715317

MIRROR



PART NO.
MRVL02R

DESCRIPTION
MIRROR VL W/SIGNAL AND
DEFROST BLACK RH

OE CROSS REFERENCE
82715382

MIRROR



PART NO.
MRVL02R-C

DESCRIPTION
MIRROR VL W/SIGNAL AND
DEFROST CHR BLK A

OE CROSS REFERENCE
82715319

MIRROR



PART NO.
MRVL03L

DESCRIPTION
MIRROR VL W/DEFROST BLACK LH

OE CROSS REFERENCE
82715380, 84720057, 84720547,
84720542

MIRROR



PART NO.
MRVL03L-C

DESCRIPTION
MIRROR VL W/DEFROST CHROME
W/BLACK ARM L

OE CROSS REFERENCE
82715317, 82794921, 84720057,
84720547, 84720542

MIRROR



PART NO.
MRVL03R

DESCRIPTION
MIRROR VL W/DEFROST BLACK RH

OE CROSS REFERENCE
82715382, 84720058, 84720548,
84720543

MIRROR



PART NO.
MRVL03R-C

DESCRIPTION
MIRROR VL W/DEFROST CHROME
W/BLACK ARM R

OE CROSS REFERENCE
82794924, 84720058, 84720548,
84720543

DOOR HANDLE



PART NO.
DRH061000L

DESCRIPTION
HANDLE-DOOR OUTSIDE BLACK LH

OE CROSS REFERENCE
20398466

DOOR HANDLE



PART NO.
DRH061000R

DESCRIPTION
HANDLE-DOOR OUTSIDE BLACK RH

OE CROSS REFERENCE
20398467

DOOR HANDLE



PART NO.
DRH061001L

DESCRIPTION
HANDLE-DOOR OUTSIDE BLACK W/
CHROME LH

OE CROSS REFERENCE
20398466, 20398466-MA

DOOR HANDLE



PART NO.
DRH061001R

DESCRIPTION
HANDLE-DOOR OUTSIDE BLACK W/
CHROME RH

OE CROSS REFERENCE
20398467, 20398467-MA,
1063327

DOOR HANDLE



PART NO.
DRH061002L

DESCRIPTION
HANDLE-DOOR INSIDE BASE LH

OE CROSS REFERENCE
1063327

DOOR HANDLE



PART NO.
DRH061002R

DESCRIPTION
HANDLE-DOOR INSIDE BASE LH

OE CROSS REFERENCE
1063328

WINDSHIELD



PART NO.
DW1308-5
DW1308-20

DESCRIPTION
GLASS-VOLVO 5PK
GLASS-VOLVO 20PK

OE CROSS REFERENCE
85102569, 1619263
85102569, 1619263

QTY
5
20



WINDSHIELD

	PART NO.	DESCRIPTION	OE CROSS REFERENCE	QTY
	DW1308-5	GLASS-VOLVO 5PK	85102569, 1619263	5
	DW1308-20	GLASS-VOLVO 20PK	85102569, 1619263	20

WINDSHIELD

	PART NO.	DESCRIPTION	OE CROSS REFERENCE	QTY
	DW1525-5	GLASS-VOLVO 5PK	8084220, 85108635	5
	DW1525-20	GLASS-VOLVO 20PK	8084220, 85108635	20

WINDSHIELD

	PART NO.	DESCRIPTION	OE CROSS REFERENCE	QTY
	DW2433-10	GLASS-VOLVO VN SERIES W/LDWS BRKT 10PK	82797495	10
	DW2433-25	GLASS-VOLVO VN SERIES W/LDWS BRKT 25PK	82797495	25

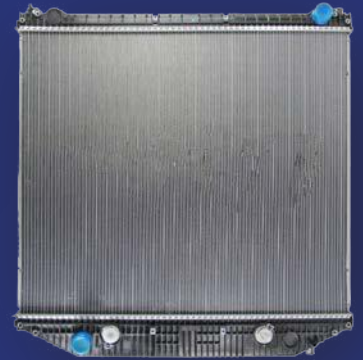
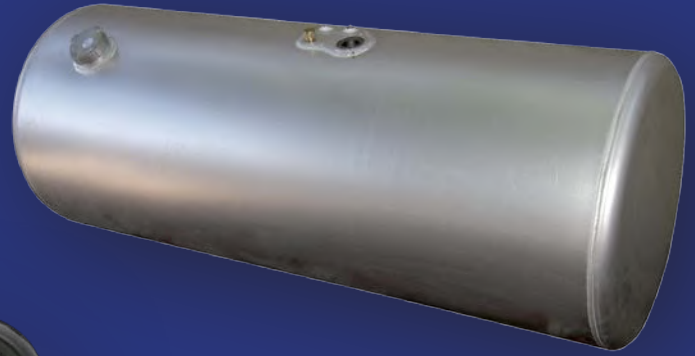



GR1NTLT17B



GR1NTLT17C



GRFLBCM2CR



GRFL6070PA



GRFLBCM2PA



GRFLBCM2PAGR



GRFLCOL0211



GRFLCAS08



GRFLCENCRB



GRKW900L



GRMKV1SP1N



GRVOLVNL

TRP All-Makes Grilles

TRP provides a variety of high quality All-Makes Grilles to protect your vehicle. TRP All-Makes Grilles are easy to install and designed for a perfect fit.

- Quick install and guaranteed fit
- Mounting hardware provided or use existing hardware to mount
- High impact resistant plastic

TRP GRILLES

Part Number	Description	OE Cross Reference
GR1NTLT17B	GRILLE-INTL LT BLACK W/BUG SCREEN	4059083C92
GR1NTLT17C	GRILLE-INTL LT CHROME W/BUG SCREEN	4039860C93
GR1NTPR008	GRILLE-INTL PROSTAR CHROME W/BUG SCREEN	3612816C91
GRFL6070PA	GRILLE-FL 60/70 W/BUG SCREEN	A17-12935-000, -001, -002, -003
GRFLBCM2CR	SURROUND-FL BCLS M2 112 CHROME W/BUG SCREEN	A17-15128-000, A1715685000
GRFLBCM2CRGR	GRILLE-FL BUSI CLS M2 112 CHROME W/BUG	A17-14787-001, 1714104001, 1714787001
GRFLBCM2PA	FL BCLS M2 112 PAINT W/BUG SCREEN	A17-15128-001, A1714518001, A1715128001, A1715685001, 1715128020
GRFLBCM2PAGR	GRILLE-FL BUSI CLS M2 112 PAINT W/BU	A17-14787-000, 1714104000, 1714787000
GRFLCOL0211	GRILLE-FL COLUMBIA CHROME W/BLACK	A17-13590-002, -004, -006, -008, -009, -010, -011, -012; A17-15251-001, -002, -003
GRFLCAS08	GRILLE-FL CASCADIA W/BUG SCREEN	A17-15624-000, -002; A17-19112-000, -007, -011, -016; A17-19933-000
GRFLCAS18	GRILLE-FL CASCADIA CA 126 W/BUG SCR	A17-20832-013
GRFLCAS18BLK	GRILLE-FL CASCADIA CA 126 W/BUG SCR BLK	A17-20832-008
GRFLCENCRB	GRILLE-FL CENTURY CHROME/BLACK W/BUG SCREEN	A17-14192-001, -012, -013; A17-15192-005, -012, -013; A17-16132-001, -002, -004
GRKW900L	GRILLE-KW W900L STEEL CHROME	L29-1003-01002, L29-10170-10002
GRKWT600	KW T-600 B SERIES ALUMINIUM SPLIT GRILLE	K146-1231
GRKWT660	GRILLE TRIM-KW T660 W/O BUG SCR	L29-1174-100
GRKWT800	GRILLE SET - KW T800 STAINLESS STEEL	K146-1312
GRMKV1SP1N	GRILLE-MACK VISION/PINNACLE W/BUG SCREEN	25166278, 20791629, 6MF580M
GRVOLVNL	GRILLE-VOLVO VNL CHROME W/BUG SCREEN	8084221
GRVOLVNL04	GRILLE-VOLVO VNL 04-18 CHROME W/BUG SCREEN	82733842



TRPK201

TRP Grille Guards

TRP Grille Guards are designed with oversized 3" stainless steel tubing that offers the most protection for your truck. Every TRP Grille Guard comes with heavy-duty mounting brackets included. The high polished stainless steel provides a maintenance free finish that will not rust. TRP Grille Guards are compatible with all major collision mitigation systems and factory fog lights. Guards can be installed in as little as 30 min and are backed by a 1-year, unlimited mile warranty.

- 3" Diameter Stainless Steel
- CMS Radar Compatible
- Fog Light Compatible
- 3/8" Heavy Duty Mounting Brackets
- High Polish - Maintenance Free Finish
- Easy Install - No Power Tools Required

TRP GRILLE GUARDS

Part Number	Description	Application
TRPF201	Cascadia Grille Guard '04-'17 T	Cascadia '04-'17 T
TRPF201B	Cascadia Grille Guard	Cascadia '04-'17 T
TRPF202	Cascadia Grille Guard '18 UP	Cascadia '18 Up
TRPF202B	Cascadia Grille Guard	Cascadia '18 Up
TRPK201	Kenworth T680 Grille Guard '11 Up	Kenworth T680 '11 Up
TRPK201B	Black Powder-Coated T680 Grille Guard	Kenworth T680 '11 Up
TRPK202	Kenworth W990 Grille Guard	Kenworth '21
TRPK202B	Kenworth W990 Grille Guard Black	Kenworth '21
TRPK203	Grille Guard Kenworth T680 Next Gen 21-Up SS	T680 Next Gen 21-Up SS
TRPK203B	Grille Guard Kenworth T680 Next Gen 21-Up Black	T680 Next Gen 21-Up Black
TRPN201	ProStar LT Grille Guard '08 Up	ProStar '08 Up
TRPN201B	ProStar LT Grille Guard '08 Up Black	ProStar '08 Up
TRPP201	Peterbilt 579 Grille Guard '12 Up	Peterbilt 579 '12 Up
TRPP201B	Black Powder-Coated 579 Grille Guard	Peterbilt 579 '12 Up
TRPP202	Peterbilt 379/567 Grille Guard SS	Peterbilt 379/567
TRPP202B	Peterbilt 379/567 Grille Guard Black	Peterbilt 379/567
TRPP203	Grille Guard Peterbilt 579 Next Gen 21-Up SS	Peterbilt 579 '21 Up
TRPP203B	Grille Guard Peterbilt 579 Next Gen 21-Up Black	Peterbilt 579 '21 Up
TRPP204	Grille Guard Peterbilt 389 '08 Up SS	Peterbilt 389 '08 Up
TRPP204B	Grille Guard Peterbilt 389 '08 Up Black	Peterbilt 389 '08 Up
TRPV201	VNL/VNR Grille Guard '03-'16	VNL/VNR Grille Guard '03-'16
TRPV202	VNL/VNR Grille Guard '18 Up	VNL/VNR Grille Guard '18 Up
TRPW202	5700 CAS Grille Guard '16 Up	Cascadia '16 Up



TRP All-Makes Hoods

TRP Hoods provide the highest quality hoods in the aftermarket. Hoods cover a wide range of popular makes and models. TRP Hoods are made from high quality reinforced fiberglass (some exclusions may apply) and come with a white gelcoat finish ready to sand, prime and paint.

- High-Quality Reinforced Fiberglass
- White Sandable Gelcoat Finish
- Pre-Paid Freight and Direct Ship
- Pre-Drilled Holes for Mounting and Accessories



AMHFL012-C
Freightliner Cascadia '08-18



AMHPB005-C
Peterbilt Model 387 '99+



AMHVL002-C
Volvo VNL '04+



AMHKW009-C
Kenworth W900L '02+



AMHMK008-C
MACK Granite CV '02+ with Hinge Bar



AMHNV018-C
International Prostar '08+

TRP HOODS

Part Number	Description	OE Cross Reference
AMH1007310BBB-C	Blue Bird BB Conventional Hood	10073100:bbb
AMHFD001-C	Ford Fseries 94-99	F7HZ-16612CA, F5HZ-16612A, F6HZ-16612CB, F7HZ-16612BA
AMHFD002-C	Ford Fseries 00-03	F81Z-16612BB
AMHFD003-C	Ford Fseries 650 750 04-09	5C4Z-16612-A
AMHFD004-C	Ford Fseries 650 750 04-10 w/Hinge Bar	5C4Z-16612-A
AMHFD005-C	Ford Fseries 650 750 10&Up	BC4Z-16612A, BC4Z-16612D

Part Number	Description	OE Cross Reference
AMHFD006-C	Ford Fseries 650 750 10&Up w/Hinge Bar	BC4Z-16612A, BC4Z-16612D
AMHFL001-C	Freightliner M2 106 05&Up w/Bezel Holes	A17-14802-000, A17-15121-025, A17-15459-000, A17-16639-000, A17-16903-000, A17-18196-004, A17-18197-004, A17-19133-002, A17-19133-022, A17-19133-032, A17-15459-002, A17-15462-005, A17-16394-004, A17-18190-000, A17-21139-038, A17-19218-001, A17-19218-012, A17-19133-012, A17-16908-004, A17-21136-053
AMHFL002-C	Freightliner M2 106 05&Up	A17-15457-002, A17-15457-004, A17-16425-000, A17-16901-000, A17-15457-000, A17-16902-000, A17-16908-000, A17-18196-000, A17-18197-000, A17-15457-004, A17-18189-000, A17-19133-000, A17-19133-020, A17-19725-000, A17-19218-000, A17-21136-016, A17-21136-026, A17-21139-000, A17-14920-000
AMHFL003-C	Freightliner CL120 Columbia 01-09	A17-13575-001, A17-13575-005, A17-15549-000, A17-15549-002, A17-13575-006, A17-13575-007, A17-16515-000, A17-16515-002, A17-15064-001, A17-16953-000
AMHFL004-C	Freightliner CL120 Columbia 01-09 w/Hinge Bar	A17-13575-001, A17-13575-005, A17-15549-000, A17-15549-002, A17-13575-006, A17-13575-007, A17-16515-000, A17-16515-002, A17-15064-001, A17-16953-000
AMHFL005-C	Freightliner CST120 Century 96-04	A17-12701-002, A17-13154-000, A17-13154-004, A17-13154-006, A17-15365-000, A17-15420-000
AMHFL006-C	Freightliner CST120 Century 96-04 w/Wide Hinge Bar	A17-12701-002, A17-15420-000
AMHFL007-C	Freightliner CST120 Century 96-04 w/Narrow Hinge	A17-13154-004, A17-13154-006, A17-15365-000
AMHFL008-C	Freightliner Freightliner70 Freightliner80 91-04	680-880-1957, A17-14744-004, A17-14024-004, A17-15053-000, 680-880-2057
AMHFL009-C	Freightliner FreightlinerD120 89&Up w/Hinge Bar	A17-12443-000, A17-12044-000, A17-12443-002, A17-12442-002, A17-10442-000, A17-10443-000, A17-12443-004
AMHFL010-C	Freightliner Classic XL132 98&Up w/Hinge Bar	A17-12562-001, A17-14881-002, A17-12562-006, A17-12562-008, A17-12562-009, A17-12582-001
AMHFL011-C	Freightliner CST120 Century 05&Up w/Hinge Bar	A17-15092-002, A17-15092-007, A17-15092-008, A17-15092-0010
AMHFL012-C	Freightliner Cascadia CA125 Long 08-18	A17-1534-0007, A17-15340-010, A17-15340-015
AMHFL013-C	Freightliner Cascadia CA125 Long 08-18 w/Xbar	A17-1534-0007, A17-15340-010, A17-15340-015
AMHFL014-C	Freightliner M2 112 03&Up	A17-2001-3003
AMHFL015-C	Freightliner Cascadia CA126 Long 08-18 w/Hinge Bar	A-1720392003
AMHGM001-C	GMC Cseries Topkick 95-02	25895875
AMHGM002-C	GMC Kodiak Topkick 90-94	15735481, 15966581, 15735481
AMHGM003-C	GMC C-6500 7500 8500 03&Up	25844474, 25844475, 15130953, 15130954
AMHHN001-C	HINO 258 268 338 06-10	53310E0030
AMHHN002-C	HINO 238 258 268 338 11&Up	53310E0117
AMHKW002-C	Kenworth T300 Curved w/S 94-09	K146-1193, K146-1193SPL



Part Number	Description	OE Cross Reference
AMHKW003-C	Kenworth T600 II Curved w/S 90-94	K146-1098-1200, K146-1129-120000, K146-1164-1200, K146-1165-120000, K146-1241-1200, K146-1242-120000
AMHKW004-C	Kenworth T600B Aero Curved w/S 95-97	K146-1219, K146-1218
AMHKW005-C	Kenworth T800A Freightliner w/S 87-04	K146-1031, K146-1052
AMHKW006-C	Kenworth T800B Curved w/S 95-07	K146-1293-11000, K146-1311-11000, K146-1312-110000
AMHKW007-C	Kenworth T800B Short Curved w/S 95-07	K146-1328-12000, K146-1329-120000
AMHKW008-C	Kenworth T660 08&Up	L29-1248, L29-1190
AMHKW009-C	Kenworth W900L 02&Up	L29-1003-0100002, L29-1017-0100002, L29-1017-0100002, L29-1018-0100002, L29-1113-0100002, L29-11130100002SPL, L29-1126-0100002
AMHKW011-C	Kenworth T600B Aero 97&Up	K146-1231
AMHKW012-C	Kenworth T600B Aero 97&Up w/Hinge Bar	K146-1231
AMHKW013-C	Kenworth T370 08& Up	L29-1100-301, L29-1100-101
AMHKW014-C	Kenworth W900L 94&Up	K146-1295-110012111, K146-1325, K146-1325-00SPL, K146-1326-101211
AMHKW015-C	Kenworth T800B Fiberglass 08&Up	L29-1177-121000, L29-1177-1210000SPL
AMHKW016-C	Kenworth T800B Short 08&Up	L29-1107-100000SPL
AMHKW017-C	Kenworth T800B w/BRTHR And Splt Fndr Cut 08&Up	L29-1177-2510000
AMHMK001-C	MACK RD 91&Up w/Hinge Bar	1QM5832, 1QM5780, 25136569, 1QM5835, 25136352
AMHMK002-C	MACK CH600 SBA 07&Up w/Hinge Bar	1QM5681BM, 25122195
AMHMK003-C	MACK Granite SFA 07&Up w/Hinge Bar	20802490, 23243007, 21453824, 25136189, 23210452, 1QM5937M
AMHMK004-C	MACK Granite SBA 07&Up w/Hinge Bar	20802493, 25136348, 21453832, 1QM4315M, 23243052, 1QM5929M
AMHMK005-C	MACK CH600 SFA 88-04 w/Hinge Bar	1QM-5717AM, 1QM-5717CM, 1QM-5715BM, 25122273
AMHMK006-C	MACK CHN SFA 05&Up w/Hinge Bar	25134067, 1QM-5927M
AMHMK007-C	MACK CHU613 SFA 07&Up w/Hinge Bar	82053610, 1QM4317-AM
AMHMK008-C	MACK Granite CV 02&Up w/Hinge Bar	1QM5915M4, 1QM5915M8, 1QM5915M10, 1QM5915M12
AMHNV001-C	International 8200 8300 89-01	2010717C91
AMHNV002-C	International 9400 89-94 w/Air Duct & Hinge Bar	1666401C96
AMHNV003-C	International 9400 95-96 w/Hinge Bar	2010879C92
AMHNV004-C	International 4700 4900 89-01	2023778C1, 2023778C2, 2023784C1
AMHNV005-C	International 4200 4300 4400 02-09	3535801C98
AMHNV006-C	International 4200 4300 4400 02-09 w/Hinge Bar	3535801C98
AMHNV007-C	International 4200 4300 4400 10&Up	3822156C94

Part Number	Description	OE Cross Reference
AMHNV008-C	International 4200 4300 4400 10&Up w/Hinge Bar	3822156C94
AMHNV009-C	International 7100 8100 89-01	1661723C1
AMHNV010-C	International 9200 w/S 97-99	3521968C91, 3501142C91
AMHNV011-C	International 9200 w/S 97-99 w/Hinge Bar	3521968C91, 3501142C91
AMHNV012-C	International 9200I Curved w/S 00&Up	3521968C91, 3501142C91
AMHNV013-C	International 9200I Curved w/S 00&Up w/Hinge Bar	3521968C91, 3501142C91
AMHNV014-C	International 9400 w/S 97-99	3521969C91
AMHNV015-C	International 9400 w/S 97-99 w/Hinge Bar	3521969C91
AMHNV016-C	International 9400I Curved w/S 00&Up	3551825C93
AMHNV017-C	International 9400I Curved w/S 00&Up w/Hinge Bar	3551825C93
AMHNV018-C	International Prostar Long 56" 08&Up	3611066C97, 3858844C91, 3858844C92
AMHNV019-C	International Prostar Long 56" 08&Up w/Hinge Bar	3611066C97, 3858844C91, 3858844C92
AMHNV020-C	International 4400 Durastar 02-09	3814340C92
AMHNV021-C	International 4400 Durastar 02-09 w/Hinge Bar	3814340C92
AMHNV022-C	International 4400 Durastar 10&Up	3814340C94
AMHNV023-C	International 4400 Durastar 10&Up w/Hinge Bar	3825655C94
AMHNV024-C	Navistar 8500 8600 02&Up	3554854C98, 3903687C91
AMHNV025-C	Navistar 7300 7400 7500 03-07	3537837C99
AMHNV026-C	Navistar 7300 7400 7500 03-07 w/Hinge Bar	3537837C99
AMHNV027-C	Navistar 7600 7700 03-07	3537845C97
AMHNV028-C	Navistar 7600 7700 03-07 w/Hinge Bar	3537845C97
AMHNV029-C	Navistar 9900I 124" BBC 99&Up	3552478C94
AMHNV030-C	Navistar 9900I 124" BBC 99&Up w/BRTHR Cuts	3862222C93
AMHNV031-C	Navistar 9900I Short 5900I 99&Up	3531917C91, 3552477C96, 3524263C91, 3867439C94
AMHNV032-C	Navistar 9900I Short 5900I 99&Up w/BTHR Cut	3531924C91, 3552478C96, 3557798C91, 3867440C91
AMHNV033-C	International Workstar 7400 7500 SBA 07&Up	3613760C94, 3613761C94
AMHNV034-C	International Workstar 7600 7700 SBA 07&Up	3613764C93, 3613764C96
AMHNV035-C	International Workstar 7600 7700 SBA 07&Up w/Xbar	3613764C93, 3613764C96
AMHPB001-C	Peterbilt 379 Fiberglass 88-06 w/ Stainless GRL	13-03553, L29-6062 (Fiberglass Replacement for 127" OE metal hood - Model Years 88-06)



Part Number	Description	OE Cross Reference
AMHPB002-C	Peterbilt 379 Fiberglass 88-06 w/GRL & Wide Fender	13-03553, L29-6062 (Fiberglass Replacement for 127" OE Metal hood - Model Years 88-06 with Wide Lip Fender)
AMHPB003-C	Peterbilt 357 378 SFA 97&Up w/O GRL Assy	13-04820A401
AMHPB004-C	Peterbilt 357 378 SFA 97&Up w/GRL Assy	13-04820A401
AMHPB005-C	Peterbilt 387 Aero SBA Long 99&Up	13-04771, 13-04777, 13-04778
AMHPB006-C	Peterbilt 386 Aero Hood 2006&Up	L29-6036, L29-6039, L29-6117-10000, L29-6094-10200, L29-6095-10200, L29-6184-20000
AMHPB007-C	Peterbilt 379 Alum 88-06 w/Fender	13-03553, L29-6062 (Replacement for OE metal hood - Model Years 88-06)
AMHPB008-C	Peterbilt 379 Fiberglass Short Hood 88-06	13-03552, L29-6061
AMHPB009-C	Peterbilt 389 Aluminum Hood w/ Fiberglass Fenders	L29-6111-1000
AMHVL001-C	Volvo VNL 98-02	20377848, 20377850, 20370861, 20377849, 20378059
AMHVL002-C	Volvo VNL 04&Up	21113797, 21113794, 82718447, 82718448



TRP Hood Cables

TRP Hood Cables reduce the range of motion of the hood when open, which prevents the hood from opening into other parts of the body and damaging the hinges. The TRP Hood Cables come in a variety of lengths and have various applications to cover multiple truck models.

- All-Makes Applications: Kenworth, Peterbilt, Volvo, International, Freightliner, GM
- All-Steel Core Cable with high strength and wear resistance
- Fastening is firm and will not fall off easily

TRP HOOD CABLES

Part Number	Description	Model	OE Part Numbers
HCBLFL650	CABLE-HOOD FRTLNR 650MM	Freightliner	A17-18481-000
HCBLFL819	CABLE-HOOD FRTLNR 819MM	Freightliner	A1712756000
HCBLGM749	CABLE-HOOD GM 749MM	GM	15630982, 15676515
HCBLKW1070	CABLE-HOOD KW 1070MM	Kenworth	L92-1001-070
HCBLKW1275	CABLE-HOOD KW 1275MM	Kenworth	L92-6017-1275
HCBLKW1397	CABLE-HOOD KW 1397MM	Kenworth	K068-5769-1
HCBLKW270	CABLE-HOOD KW 270MM	Kenworth	L92-1005-270
HCBLKW770	CABLE-HOOD KW 770MM	Kenworth	L92-1016-0770
HCBLKW895	CABLE-HOOD KW 895MM	Kenworth	K068-844
HCBLKW965	CABLE-HOOD KW 965MM	Kenworth	L92-6017-0965
HCBLNV737	CABLE-HOOD INTL 737MM	International	483687C2
HCBLPB1065	CABLE-HOOD PB 1065MM	Peterbilt	L92-6017-1065
HCBLPB580	CABLE-HOOD PB 580MM	Peterbilt	L92-6000-0580
HCBLPB590	CABLE-HOOD PB 590MM	Peterbilt	13-03511
HCBLPB700	CABLE-HOOD PB 700MM	Peterbilt	L92-6000-0700
HCBLPB718	CABLE-HOOD PB 718MM	Peterbilt	L92-6000-0718
HCBLPB762	CABLE-HOOD PB 762MM	Peterbilt	13-04503-030
HCBLPB875	CABLE-HOOD PB 875MM	Peterbilt	L92-6017-0875
HCBLPB995	CABLE-HOOD KW/PB 995MM	Kenworth/Peterbilt	L92-6017-0995
HCBLVL1676	CABLE-HOOD VOLVO 1676MM	Volvo	20377497, 20448267, 20462437



TRP HOOD SPRINGS



TRP Hood Springs

TRP Hood Springs are a vital replacement part that assists in the operation of the hood. These hood springs are a low-cost option and are made from durable high-quality materials.

- Easy to install
- Color matched to the OE part for easy identification
- Packaged and sold Individually

TRP HOOD SPRINGS

Part Number	Description	OE Cross Reference
HS1309	SPRING - HOOD RED PETERBILT 389/379	L81-6009
HS1368	SPRING - HOOD GREEN PETERBILT 386/388/389/384	L81-6008
HS1369	SPRING - HOOD TILT BLACK 379/378/377/386/385	13-03569
HS1379	SPRING - HOOD GRAY PETERBILT	13-03879
HS2496	SPRING - HOOD BLACK 359	13-02495
HS2514	SPRING - HOOD MACK CX	25171284
HS2519	SPRING - HOOD MACK CH & CV	25158019
HS3046	SPRING - HOOD BLUE- PETERBILT 379/378/377/357	13-03879, 13-04638
HS3531	SPRING - HOOD INTERNATIONAL 4000	1675762C3
HS3532	SPRING - HOOD INTERNATIONAL 9000	3588532C2
HS3533	SPRING - HOOD INTERNATIONAL 9200 & 9400	598574C3
HS6010	SPRING - HOOD WHITE 365/367	L81-6010
HS7100	SPRING - HOOD RED - KENWORTH T800/T600/W900	K224-81
HS7102	SPRING - HOOD WHITE - KENWORTH W900/T2000/T600	L71-1002
HS7104	SPRING - HOOD BROWN KENWORTH W900/T800/C500/C550	L71-1004
HS7106	SPRING - HOOD BLUE KENWORTH T800/W900/C500/T600	K224-86
HS7107	SPRING - HOOD BLACK - KENWORTH W900B	K224-35
HS7150	SPRING - HOOD YELLOW KENWORTH T800/T400/T450/W900	K224-95
HS72691	SPRING - HOOD FREIGHTLINER FLD & CLASSIC	17-12069-001



G112504



G110342



A130143



A150162

AIR CLEANERS

PART#	DESCRIPTION	INLET	OUTLET	OE CROSS REFERENCE
A130085	EBA 13" Peterbilt	7"	7"	EBA13-0085
A130108	EBA 13" Peterbilt	7"	7"	EBA13-0108
A130115	ERA 13" Kenworth	6"	6"	ERA13-0115
A130141	13" Left Stainless Steel, Branded Kenworth	N/A	7"	ERA130141
A130142	13" Right Stainless Steel, Branded Kenworth	N/A	7"	ERA130143
A150137	ERA 15", Peterbilt 367, 388, 389 Cowl Mount Assy	7"	7"	ERA150137
A150138	ERA 15", Peterbilt & Kenworth	7"	7"	ERA150138
A150163	15" Left Stainless Steel, Branded Kenworth	N/A	7"	ERA150163
A150164	15" Right Stainless Steel, Branded Kenworth	N/A	7"	ERA150164
G110171	EPG 11" W/ Round Inlet Peterbilt 378 Under Hood	9.75" Bellows Inlet	6"	05-18924
G110342	ECG 11", Peterbilt 335 Under Hood	9.75" Bellows Inlet	5"	D37-6005
G112504	ECG 11", Kenworth T600, T800 & Peterbilt 367 Under Hood	7"	7"	05-14838

Consistent OEM Quality:

Increase the performance and life of your engine by delivering clean air when it needs it most.

*See dealer for additional applications not listed and product specifications.



ACHSS13



ACHSS13K



ACHSS15K



ACHSS15

TRP Air Cleaners

The TRP Stainless Steel Air Cleaner Kits combine high performance with an eye-catching stainless-steel finish. They are offered in two different sizes - 15" or 13" and can come with or without a kit. The vortex style air cleaners have a reputation for a large dirt holding capacity along with an ease of serviceability.

- No visible bolt and nuts on exterior making for a very clean stainless-steel finish
- Complete kit comes with Air Cleaner Housing, 2 mounting straps, and 1 mounting plate
- Made with high quality products to ensure longevity
Packaged and sold Individually

TRP AIR CLEANERS

Part Number	Description	OE Cross Reference
ACHBRA15	BRACKET-AIR CLEANER PB 15IN	N/A
ACHSS13	CLEANER-AIR STAINLESS STEEL 13IN	N/A
ACHSS13K	CLEANER-AIR STAINLESS STEEL 13IN KIT	N/A
ACHSS15	CLEANER-AIR STAINLESS STEEL 15IN	N/A
ACHSS15K	CLEANER-AIR STAINLESS STEEL 15IN KIT	N/A
ACHSTR15PB	STRAP-AIR CLEANER PB 15IN	N/A



TRP Fenders

TRP 379 Fenders

- Manufactured from 5052 Grade Aluminum
- Primed and ready for paint
- Lightweight aluminum construction
- OEM Specs

Peterbilt 388/389 and Kenworth T800 Fenders

- High Quality Fiberglass
- Sandable Gelcoat Finish
- Primed and Ready to Paint
- Pre-Drilled Holes for Mounting

TRP FENDERS

Part Number	Description	OE PN
FN4905L	FENDER-379 ALUMINUM LH	15-04905M001L
FN4905R	FENDER-379 ALUMINUM RH	15-04905M001R
FNKW2011R	KW T800 FENDER EXTENSION RH	L29-1177-211000
FNKW2012L	KW T800 FENDER EXTENSION LH	L29-1177-211000
FNPB911R	PB 388/89 FRONT FENDER RH	L29-6111-1000
FNPB912L	PB 388/89 FRONT FENDER LH	L29-6111-1000
FNPB920R	PB 388/89 FRONT WIDE FENDER RH	L29-6111-1000
FNPB921L	PB 388/89 FRONT WIDE FENDER LH	L29-6111-1000



TRP RADIATORS & CHARGE AIR COOLER



CAC61-1001TRP



CAC61-1005TRP



CAC61-1006TRP



CAC61-1042TRP



CAC61-1008TRP



CAC61-1015TRP



CAC61-1557TRP



RAD42-10171TRP



CAC61-1553TRP



RAD42-10205TRP

TRP Radiators and Charge Air Coolers

Tasked with preventing the vehicle from overheating, the radiator is vital to keeping vehicles up and running.

- Longer header tabs for increased pressure resistance & leak reduction
- Age-hardening header plate that strengthens over time
- Double-Hemmed fin design for increased stability and heat disbursement
- Double-Header plate design for increased pressure and vibration resistance

TRP RADIATORS & CHARGE AIR COOLERS

Part Number	Description	OE Cross Reference	Core Dimensions (Length x Height x Width)	Number of Rows	Applications	Surge Tank?
CAC61-1001TRP	Charge Air Cooler, Ford L Series	1E3539	39.31 x 26.44 x 1.52	1	Ford L9000 10.0 L6;1988-1997	No
CAC61-1005TRP	Charge Air Cooler, Freightliner Fld 120	121388000	30.52 x 21.38 x 2.76	1	Freightliner Fl And Century Series 89-94	No
CAC61-1006TRP	Charge Air Cooler, Freightliner Columbia	4863905001	30.52 x 21.38 x 2.76	1	Freightliner Century Class 82-02	No
CAC61-1008TRP	Charge Air Cooler, International 8000 & 9000 Series,	1E4151	30.16 x 21.38 x 2.76	1	International 8000 And 9000 Series 85-07	No
CAC61-1015TRP	Charge Air Cooler, Kenworth T600, T800, W900	K093-63 or K093-13 - Tube & Fin, 4880905004	40.56 x 24.49 x 1.97	1	Kenworth T600 / T800 / W900 86-07	No
CAC61-1024TRP	Charge Air Cooler, Peterbilt 357, 378, 378	IE3816, F31-6049	28.71 x 27.03 x 2.21	1	Peterbilt Conventionals 82-07	No

TRP RADIATORS & CHARGE AIR COOLER



Part Number	Description	OE Cross Reference	Core Dimensions (Length x Height x Width)	Number of Rows	Applications	Surge Tank?
CAC61-1042TRP	Charge Air Cooler, Freightliner Columbia 2007+	BHT59279	33.35 x 30.32 x 1.97	1	Freightliner Columbia 90-07	No
CAC61-1553TRP	Charge Air Cooler, Peterbilt 357, 378, 379	ABPN09BH20B, F31-6049	36.46 x 26.62 x 1.97	1	Peterbilt 357-377-378-379-385 Bar-And-Plate	No
CAC61-1557TRP	Charge Air Cooler, Kenworth T600, T800, W900	K093-63 or K093-13 - Bar & Plate, DURKE-DAC10B	33.35 x 30.32 x 1.97	1	Kenworth T600- T800- W900 95-07 Bar And Plate	No
RAD42-10002TRP	Radiator, International 2500, 2600, 8300, 9200	1616363C91	28.71 x 27.03 x 2.21	2	International 9100 Thru 9400 93-03	No
RAD42-10003TRP	Radiator, Freightliner Conventional 93 & Up	516378000	40.95 x 27.64 x 2.21	2	Freightliner Fld112, 120 91-02	No
RAD42-10071TRP	Radiator, Freightliner Century Class Series	516255001	35.83 x 26.34 x 2.21	2	Freightliner Fld120/ Century Class 91-03	No
RAD42-10114TRP	Radiator, International 4900 Series Mt	3A48118D2	35.83 x 30.63 x 1.89	3	International 4900 7.3 V8 W/T Oil Cooler 94-00	No
RAD42-10171TRP	Radiator, Mack Ch Series 92-04	3MF5532M	31.00 x 12.75 x 2.50	2	Volvo / Mack Ch Series 95-04	No
RAD42-10205TRP	Radiator, Volvo Vnl 4200 Series	126435	28.94 x 38.47 x 2.21	2	Volvo / Mack Vnl 4200 Series 00-07	No
RAD42-10322TRP	Radiator, Peterbilt 357, 375 Series	07-06657A011	34.93 x 35.50 x 2.25	3	Peterbilt 357/ 375/ 379/ 385w/T Surge Tank 95-04	Yes
RADS10325TRP	Radiator-Kenworth 93-09	X5101-02 or X5601-08 or 1A020256, IE62135	36.25 x 34.62 x 2.00	4	Kenworth T600/T800 94-05	Yes
RAD42-10334TRP	Radiator, Peterbilt 357, 375 Series	BTC1102R, 07-06657A011	40.00 x 28.62 x 2.12	4	Peterbilt Conventionals 90-94	Yes



TRP Metal Bumpers

The TRP all-makes bumper line is expanded and better than ever, now offering bumpers for approximately 170 truck models, including standard replacement bumpers and some custom options. Made in the USA with all metal, one-piece construction, they are designed and tested to strict SC4/5 corrosion protection standards - the highest levels.

- 350+ part numbers
- Material choices are chrome steel, 304 stainless steel or black powder coated steel
- Chrome steel bumpers include black backside paint for a great look and additional corrosion resistance

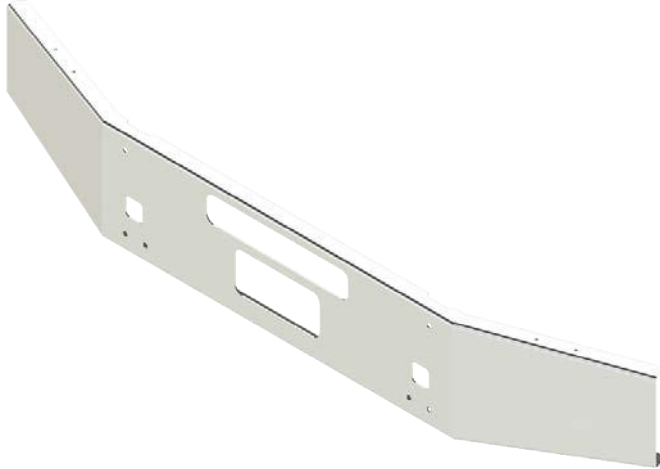

TRP METAL BUMPERS

Part Number	Description
TX0452011-18TF	BUMPER INTL PROSTAR FIXED MNT,FOG,CHROME
TX0510210-02TS	BUMPER-KENWORTH W900B
TX0510210-06PL	BUMPER W900B,L,1982-2010,18"TXSQ,PALLET
TX0510210-06TS	BUMPER-KW W900L 18" SQ. ROLL END
TX05X0011-25NS	BUMPER-T800 CONV SET BACK 14" OPEN END
TX08C0020-02TS	BUMPER-PB 378 & 379 CONV 16" TPR ROL END
TX08C0020-06NP	BUMPER PB 378,379 CONV, 18"TX,TOW,PALLET
TX08C0020-06TS	BUMPER-PB 378 & 379 CONV 18" SQ ROLL END
TX08C0020-11TS	BUMPER-PB 378 & 379 CONV 18" SQ. BOX END
TX08C0020-51NS	BUMPER PB 378,379 CONV,20"BOX,TOW
TX08U0215-28NS	BUMPER PB 386 2006-NEWER 13" SBA,STEP,TOW
TX08V0010-02NS	BUMPER PB 389,16" TPR,10GA,TOW,NO SHIELDS
TX08V0010-06TS	BUMPER PB 388,389,365 2007-new 18"TX,TOW
TX08V0013-02NS	BUMPER PB 388 389,TOW,BELLYPAN,16IN TPR
TX7510210-06TS	BUMPER-KW W900L 18" SQ. ROLL END
TX75G0011-26NS	BUMPER-KW T800 CONV 14" TPR BRK/OPEN END



MRFL01L



MRFL02L



MRKP01R



MRKW01L
(Comes with Temp Sensor)

TRP Mirrors

TRP Aero Mirrors are tested, reliable and industry proven! Each mirror is of high quality and manufactured with a variety of adjustable settings, materials and colors. TRP Aero Mirrors can withstand harsh demands of any job both on and off the highway. In short, these versatile mirrors enable drivers to safely see and execute any job. The mirrors come with PACCAR's standard one-year warranty.

- Both the driver's side and the passenger's side are developed in accordance with OE mirrors to ensure that the products 100% fit the trucks
- Black and Chrome versions are available depending on customer preference
- Aerodynamic design helps reduce fuel consumption
- ISO 9001 Certified

TRP MIRRORS

Part Number	Description	OE Cross Reference	Application
MRFL01L	FREIGHTLINER MIRROR W/DEFROST, BLACK, LH	A22-60713-002	FREIGHTLINER CASCADIA, 2008-2014
MRFL01L-C	FREIGHTLINER MIRROR W/DEFROST, CHROME, LH	A22-60713-005	FREIGHTLINER CASCADIA, 2008-2015
MRFL01R	FREIGHTLINER MIRROR W/DEFROST, BLACK, RH	A22-60713-001	FREIGHTLINER CASCADIA, 2008-2016
MRFL01R-C	FREIGHTLINER MIRROR W/DEFROST, CHROME, RH	A22-60713-003	FREIGHTLINER CASCADIA, 2008-2017
MRFL02L	HOOD-MIRROR FL W/O DEFROST BLK LH	A22-66565-000	FREIGHTLINER CASCADIA, 2008-2018
MRFL02L-C	HOOD-MIRROR FL W/O DEFROST CHR LH	A22-66565-002	FREIGHTLINER CASCADIA, 2008-2018
MRFL02R	HOOD-MIRROR FL W/O DEFROST BLK RH	A22-66565-001	FREIGHTLINER CASCADIA, 2008-2018
MRFL02R-C	HOOD-MIRROR FL W/O DEFROST CHR RH	A22-66565-003	FREIGHTLINER CASCADIA, 2008-2018
MRKP01L	MIRROR KW PB DEFROST AND TEMP SENSOR BLK	N/A	KENWORTH T2000 / T700 / PETERBILT 387 / 587
MRKP01R	MIRROR KW PB DEFROST BLK RH	N/A	KENWORTH T2000 / T700 / PETERBILT 387 / 587
MRKW01L	MIRROR KW DEFROST AND TEMP SENSOR BLK LH	N/A	KENWORTH T170 / T270 / T370 / T440 / T470 / T600 / T660 / T800



TRP AERO MIRRORS

Part Number	Description	OE Cross Reference	Application
MRKW01L-C	MIRROR KW DEFROST/TEMP SENSOR CHROME BLK	N/A	KENWORTH T170 / T270 / T370 / T440 / T470 / T600 / T660 / T800
MRKW01R	MIRROR KW DEFROST BLK RH	N/A	KENWORTH T170 / T270 / T370 / T440 / T470 / T600 / T660 / T800
MRKW01R-C	MIRROR KW DEFROST CHROME RH	N/A	KENWORTH T170 / T270 / T370 / T440 / T470 / T600 / T660 / T800
MRVL01L	MIRROR VL W/DEFROST BLACK LH	82239803	VOLVO VNL 2004-2012
MRVL01L-C	MIRROR VL W/DEFROST CHROME W/BLACK ARM L	82239815 / 20701416	VOLVO VNL 2004-2012
MRVL01R	MIRROR VL W/DEFROST BLACK RH	82239804	VOLVO VNL 2004-2012
MRVL01R-C	MIRROR VL W/DEFROST CHROME W/BLACK ARM R	82239816 / 20701418	VOLVO VNL 2004-2012
MRVL02L	MIRROR VL W/SIGNAL AND DEFROST BLACK LH	82715380	VOLVO VNL 2012-On
MRVL02L-C	MIRROR VL W/SIGNAL AND DEFROST CHR BLK A	82715317	VOLVO VNL 2012-On
MRVL02R	MIRROR VL W/SIGNAL AND DEFROST BLACK RH	82715382	VOLVO VNL 2012-On
MRVL02R-C	MIRROR VL W/SIGNAL AND DEFROST CHR BLK A	82715319	VOLVO VNL 2012-On
MRVL03L	MIRROR VL W/DEFROST BLACK LH	82715380, 84720057, 84720547, 84720542	VOLVO VNL 2012-On
MRVL03L-C	MIRROR VL W/DEFROST CHROME W/BLACK ARM L	82715317, 82794921, 84720057, 84720547, 84720542	VOLVO VNL 2012-On
MRVL03R	MIRROR VL W/DEFROST BLACK RH	82715382, 84720058, 84720548, 84720543	VOLVO VNL 2012-On
MRVL03R-C	MIRROR VL W/DEFROST CHROME W/BLACK ARM R	82794924, 84720058, 84720548, 84720543	VOLVO VNL 2012-On



TRP Windshields

The TRP glass program brings you the highest quality aftermarket replacement windshields at affordable prices. TRP glass provides improved clarity over other replacement glass which means increased visibility and less driver fatigue. TRP replacement windshields meet stringent quality standards to ensure proper fit, reducing installation time. All TRP windshields are made with your safety in mind through a lamination process where two pieces of glass are bonded together by a vinyl inner layer. If an accident occurs, the vinyl inner layer prevents the glass from shattering and provides strength which helps to keep occupants in the vehicle during a head-on collision. The glass breaks, but the pieces stick to the vinyl.

- High Quality Replacement Windshields
- Popular All-Makes Applications, including City and School Buses
- Meets stringent quality standards to ensure proper fit, while also reducing installation time
- Meets all DOT safety standards
- Manufactured to OEM specifications to ensure consistent fit and easy installation
- Convenient package quantities fit your business requirements

TRP WINDSHIELDS

Part Number	Description	OE Cross Reference
DW1310-10	GLASS T2000/387 10PK	R44-1021, R44-1041
GB482010-25	GLASS-AM-TRAN GB 25PK	437282002
GB482010-5	GLASS-AM-TRAN GB 5PK	437282002
DW1379-30	GLASS-ARGOSY 30PK	N/A
DW1380-30	GLASS-ARGOSY 30PK	N/A
GB482030-25	GLASS-BLUEBIRD ALL AMERICAN 25PK	00357335
GB482030-5	GLASS-BLUEBIRD ALL AMERICAN 5PK	00357335
GB48298GBN-25	GLASS-BLUEBIRD ALL AMERICAN LH T3 SHADED 25PK	N/A
GB48298GBN-5	GLASS-BLUEBIRD ALL AMERICAN LH T3 SHADED 5PK	N/A
GB48298GTN-25	GLASS-BLUEBIRD ALL AMERICAN LH T3 TINTED 25PK	N/A
GB48298GTN-5	GLASS-BLUEBIRD ALL AMERICAN LH T3 TINTED 5PK	N/A
GB48295GBN-25	GLASS-BLUEBIRD ALL AMERICAN RH T3 SHADED 25PK	N/A
GB48295GBN-5	GLASS-BLUEBIRD ALL AMERICAN RH T3 SHADED 5PK	N/A
GB48295GTN-25	GLASS-BLUEBIRD ALL AMERICAN RH T3 TINTED 25PK	N/A
GB48295GTN-5	GLASS-BLUEBIRD ALL AMERICAN RH T3 TINTED 5PK	N/A
GB48202-25	GLASS-BLUEBIRD CONVENTIONAL 25PK	00357376



Part Number	Description	OE Cross Reference
GB48202-5	GLASS-BLUEBIRD CONVENTIONAL 5PK	00357376
GB482050-25	GLASS-BLUEBIRD CONVENTIONAL LEFT 25PK	00343830
GB482050-5	GLASS-BLUEBIRD CONVENTIONAL LEFT 5PK	00343830
GB482051-25	GLASS-BLUEBIRD CONVENTIONAL RIGHT 25PK	00343822
GB482051-5	GLASS-BLUEBIRD CONVENTIONAL RIGHT 5PK	00343822
GB482052-30	GLASS-BLUEBIRD TC/2000 GB 30PK	01551241
GB482053-30	GLASS-BLUEBIRD TC/2000 GT 30PK	01551233
GB482053-5	GLASS-BLUEBIRD TC/2000 GT 5PK	01551233
GB482054-25	GLASS-BLUEBIRD TC/2000 LEFT GB 25PK	01551217
GB482054-5	GLASS-BLUEBIRD TC/2000 LEFT GB 5PK	01551217
GB482055-25	GLASS-BLUEBIRD TC/2000 LEFT GT 25PK	01551191
GB482056-25	GLASS-BLUEBIRD TC/2000 RIGHT GB 25PK	01551209
GB482056-5	GLASS-BLUEBIRD TC/2000 RIGHT GB 5PK	01551209
GB482057-25	GLASS-BLUEBIRD TC/2000 RIGHT GT 25PK	01551183
GB482057-5	GLASS-BLUEBIRD TC/2000 RIGHT GT 5PK	01551183
GB48203-25	GLASS-CARPENTER GT 25PK	N/A
GB48203-5	GLASS-CARPENTER GT 5PK	N/A
GB48206-25	GLASS-CARPENTER SPECIAL 25PK	N/A
GB48206-5	GLASS-CARPENTER SPECIAL 5PK	N/A
DW2649-15	GLASS-FL CASCADIA 19 W/BRKT 15PK	A18-71102-000, A18-71102-001
DW2649-5	GLASS-FL CASCADIA 19 W/BRKT 5PK	A18-71102-000, A18-71102-001
DW911-5	GLASS-FORD 5PK	E0TZ-1003100A, E0TZ-1003100B
DW1099-5	GLASS-FORD 5PK	F2TB-1503100AA
DW828-5	GLASS-FORD 5PK	D4HB-8003100Z
DW997-5	GLASS-FORD 5PK	F1HT-6803102AA
DW1254-20	GLASS-FORD L SERIES CONV CAB 20PK	F6HT-8003100AA
DW1254-5	GLASS-FORD L SERIES CONV CAB 5PK	F6HT-8003100AA
DL4746-20	GLASS-FREIGHTLINER 20PK	18-23529-003
DW1000-20	GLASS-FREIGHTLINER 20PK	681-671-03-10
DW1488-20	GLASS-FREIGHTLINER 20PK	901-671-0310
DW1494-20	GLASS-FREIGHTLINER 20PK	A18-45300-003, A18-63440-000
DW1302-30	GLASS-FREIGHTLINER 30PK	18-32581-001, 18-46741-004
DW1303-30	GLASS-FREIGHTLINER 30PK	18-32581-000, 18-46741-003

Part Number	Description	OE Cross Reference
DL4746-5	GLASS-FREIGHTLINER 5PK	18-23529-003
DW1000-5	GLASS-FREIGHTLINER 5PK	681-671-03-10
DW1302-5	GLASS-FREIGHTLINER 5PK	18-32581-001, 18-46741-004
DW1303-5	GLASS-FREIGHTLINER 5PK	18-32581-000, 18-46741-003
DW1439-5	GLASS-FREIGHTLINER 5PK	18-42264-000
DW1488-5	GLASS-FREIGHTLINER 5PK	901-671-0310
DW1494-5	GLASS-FREIGHTLINER 5PK	A18-45300-003, A18-63440-000
DW2419-20	GLASS-FREIGHTLINER CASCADIA 20-PK	A18-67040-001, A18-67040-002, A18-67040-006
DW2409-20	GLASS-FREIGHTLINER CASCADIA 20-PK LDWS	A18-67040-001, A18-67040-002
DW2419-25	GLASS-FREIGHTLINER CASCADIA 25-PK	A18-67040-001, A18-67040-002, A18-67040-006
DW1731-30	GLASS-FREIGHTLINER CASCADIA 30PK	A18-59152-001
DW1732-30	GLASS-FREIGHTLINER CASCADIA 30PK	A18-59152-000
DW1731-5	GLASS-FREIGHTLINER CASCADIA 5PK	A18-59152-001
DW1732-5	GLASS-FREIGHTLINER CASCADIA 5PK	A18-59152-000
DW2419-5	GLASS-FREIGHTLINER CASCADIA 5-PK	A18-67040-001, A18-67040-002, A18-67040-006
DW2409-5	GLASS-FREIGHTLINER CASCADIA 5-PK LDWS	A18-67040-001, A18-67040-002
DW1231-20	GLASS-ISUZU 20PK	N/A
DW1656-10	GLASS-KENWORTH 10PK	R44-1033R
DW1657-10	GLASS-KENWORTH 10PK	R44-1033
DL4717-10	GLASS-KENWORTH 10PK	K136-157, R44-1036
DW1164-30	GLASS-KENWORTH 2 PC CURV(30EA=1CRATE)	K136-205, R44-1040
DW1655-30	GLASS-KENWORTH 30PK	R44-1032, R44-1043
DW1656-30	GLASS-KENWORTH 30PK	R44-1033R
DW1657-30	GLASS-KENWORTH 30PK	R44-1033
DL4717-30	GLASS-KENWORTH 30PK	K136-157, R44-1036
DW1707-30	GLASS-KENWORTH 30PK	R44-1031
DW1139-5	GLASS-KENWORTH 5 PK	K136-201, R44-1032, R44-1039
DW1163-5	GLASS-KENWORTH 5PK	K136-205R, R44-1040R
DW1655-5	GLASS-KENWORTH 5PK	R44-1032, R44-1043
DW1656-5	GLASS-KENWORTH 5PK	R44-1033R
DW1657-5	GLASS-KENWORTH 5PK	R44-1033
DL4717-5	GLASS-KENWORTH 5PK	K136-157, R44-1036



Part Number	Description	OE Cross Reference
DW1164-5	GLASS-KENWORTH 5PK	K136-205, R44-1040
DW1707-5	GLASS-KENWORTH 5PK	R44-1031
DW1139-10	GLASS-KW 1PC CURVED 10 PK	K136-201, R44-1032, R44-1039
DW1139-30	GLASS-KW,1PC CURVED(30EA=1CRATE)	K136-201, R44-1032, R44-1039
DW1163-30	GLASS-KW,2PC CURVED(30EA=1CRATE)	K136-205R, R44-1040R
DL2752-20	GLASS-MACK 20PK	9QT413M
DW1081-30	GLASS-MACK 30PK	9QT522A, 9QT522AM
DW1080-30	GLASS-MACK 30PK	9QT521A, 9QT521AM
DW1315-30	GLASS-MACK 30PK	9QT416M
DW662-30	GLASS-MACK 30PK	9QT513A
DW663-30	GLASS-MACK 30PK	9QT514A
DL2752-5	GLASS-MACK 5PK	9QT413M
DW1080-5	GLASS-MACK 5PK	9QT521A, 9QT521AM
DW1081-5	GLASS-MACK 5PK	9QT522A, 9QT522AM
DW1315-5	GLASS-MACK 5PK	9QT416M
DW662-5	GLASS-MACK 5PK	9QT513A
DW663-5	GLASS-MACK 5PK	9QT514A
DW933-5	GLASS-MACK 5PK	9QT414M, 9QT517M
DW953-5	GLASS-MACK 5PK	9QT517M
DW954-5	GLASS-MACK 5PK	9QT518M
FW02014-20	GLASS-MITSUBISHI 20PK	N/A
FW02014-5	GLASS-MITSUBISHI 5PK	N/A
DW1451-20	GLASS-NAVISTAR 20PK	N/A
DL4586-30	GLASS-NAVISTAR 30PK	N/A
DL4586-5	GLASS-NAVISTAR 5PK	403339C1
DL4645-5	GLASS-NAVISTAR 5PK	443996C1
DL4744-5	GLASS-NAVISTAR 5PK	N/A
DL4761-5	GLASS-NAVISTAR 5PK	1666092C3
DT4673-5	GLASS-NAVISTAR 5PK	N/A
DW1128-5	GLASS-NAVISTAR 5PK	1670093C3
DW1451-5	GLASS-NAVISTAR 5PK	N/A
DW919-5	GLASS-NAVISTAR 5PK	N/A
DW920-5	GLASS-NAVISTAR 5PK	N/A

Part Number	Description	OE Cross Reference
GB482060-30	GLASS-NAVISTAR AMTRAN RE GB 30PK	431339002
GB482061-30	GLASS-NAVISTAR AMTRAN RE GT 30PK	431339001
GB482061-5	GLASS-NAVISTAR AMTRAN RE GT 5PK	431339001
DW1685-20	GLASS-NAVISTAR ECAP 06-10 20PK -SOLAR	3354252C4
DW1685-5	GLASS-NAVISTAR ECAP 06-10 5PK - SOLAR	3354252C4
DW1765-20	GLASS-NAVISTAR ECAP 08-10 20PK - HEATED	N/A
DW1765-5	GLASS-NAVISTAR ECAP 08-10 5PK - HEATED	3554252C4, 3554252C5, 3554252C6
GB482059-25	GLASS-NAVISTAR IC CONV 1 PC 25PK	2202541C3
GB482059-5	GLASS-NAVISTAR IC CONV 1 PC 5PK	2202541C3
GB482058-20	GLASS-NAVISTAR IC LARGE 20PK	226177002, 446177002
GB482058-5	GLASS-NAVISTAR IC LARGE 5PK	226177002, 446177002
DW1663-20	GLASS-NAVISTAR ONE PIECE ECAP 06-07 20PK	2592448C1
DW1663-5	GLASS-NAVISTAR ONE PIECE ECAP 06-07 5PK	N/A
DW1383-20	GLASS-NAVISTAR ONE PIECE ECAP 20/PK	3535577C1
DW1383-5	GLASS-NAVISTAR ONE PIECE ECAP 5/PK	3535577C1
DW2550-20	GLASS-NAVISTAR PROSTAR 2019 20PK	N/A
DW1385-20	GLASS-NAVISTAR TWO PIECE ECAP LH 20/PK	3535578C3
DW1665-20	GLASS-NAVISTAR TWO PIECE ECAP LH 20PK	2592447C1
DW1385-5	GLASS-NAVISTAR TWO PIECE ECAP LH 5/PK	3535578C3
DW1665-5	GLASS-NAVISTAR TWO PIECE ECAP LH 5PK	2592447C1
DW1664-20	GLASS-NAVISTAR TWO PIECE ECAP RH 20PK	2592446C1
DW1384-5	GLASS-NAVISTAR TWO PIECE ECAP RH 5/PK	3535579C3
DW1664-5	GLASS-NAVISTAR TWO PIECE ECAP RH 5PK	2592446C1
FW813-20	GLASS-NISSAN 20PK	N/A
FW813-5	GLASS-NISSAN 5PK	N/A
DW1036-10	GLASS-PETERBILT 10PK	20-14898R, R44-6022R
DW1037-10	GLASS-PETERBILT 10PK	20-14898L, R44-6022
DW1036-30	GLASS-PETERBILT 30PK	20-14898R, R44-6022R
DW1037-30	GLASS-PETERBILT 30PK	20-14898L, R44-6022
DL4676-5	GLASS-PETERBILT 5PK	30214-042
DW1310-20	GLASS-T2000/387 20PK	R44-1021, R44-1041
DW1310-5	GLASS-T2000/387 5PK	R44-1021, R44-1041
DW2559-10	GLASS-T680/T880 ONE PC W/LDWS BRKT 10PK	R44-6099



Part Number	Description	OE Cross Reference
DW2559-20	GLASS-T680/T880 ONE PC W/LDWS BRKT 20PK	R44-6099
DW2559-5	GLASS-T680/T880 ONE PC W/LDWS BRKT 5 PK	R44-6099
GB482042-5	GLASS-THOMAS C2 1 PC GB 5PK	100614
GB48201-25	GLASS-THOMAS CONVENTIONAL 25PK	13003372
GB48201-5	GLASS-THOMAS CONVENTIONAL 5PK	13003372
GB482015-25	GLASS-THOMAS FS 65 GB 25PK	53002860
GB482015-5	GLASS-THOMAS FS 65 GB 5PK	53002860
GB482014-25	GLASS-THOMAS FS 65 GT 25PK	53002859
GB482014-5	GLASS-THOMAS FS 65 GT 5PK	53002859
GB4820731-25	GLASS-THOMAS MVP & SAF-T-LINER GB 25PK	53000902
GB4820731-5	GLASS-THOMAS MVP & SAF-T-LINER GB 5PK	53000902
GB482009-25	GLASS-THOMAS MVP & SAF-T-LINER GT 25PK	13005374
GB482011-25	GLASS-THOMAS MVP & SAF-T-LINER GT 25PK	53000901
GB482009-5	GLASS-THOMAS MVP & SAF-T-LINER GT 5PK	13005374
GB482011-5	GLASS-THOMAS MVP & SAF-T-LINER GT 5PK	53000901
GB482028-25	GLASS-THOMAS SAF-T-LINER & MVP-EF 25PK	53001481
GB482044-25	GLASS-THOMAS SAF-T-LINER LEFT GB 25PK	53003382
GB482044-5	GLASS-THOMAS SAF-T-LINER LEFT GB 5PK	53003382
GB482045-25	GLASS-THOMAS SAF-T-LINER LEFT GT 25PK	53003183
GB482045-5	GLASS-THOMAS SAF-T-LINER LEFT GT 5PK	53003183
GB482046-25	GLASS-THOMAS SAF-T-LINER RIGHT GB 25PK	53003383
GB482046-5	GLASS-THOMAS SAF-T-LINER RIGHT GB 5PK	#N/A
GB482047-25	GLASS-THOMAS SAF-T-LINER RIGHT GT 25PK	53003184
GB482040-30	GLASS-THOMAS VISTA GB 30PK	53002003
GB482040-5	GLASS-THOMAS VISTA GB 5PK	53002003
GB482041-30	GLASS-THOMAS VISTA GT 30PK	53002002
GB482041-5	GLASS-THOMAS VISTA GT 5PK	53002002
DW1308-20	GLASS-VOLVO 20PK	85102569, 1619263
DW863-20	GLASS-VOLVO 20PK	3080293
DW864-20	GLASS-VOLVO 20PK	3080292
DW865-20	GLASS-VOLVO 20PK	3080291
DW866-20	GLASS-VOLVO 20PK	3080290
DW1525-20	GLASS-VOLVO 20PK	8084220, 85108635

Part Number	Description	OE Cross Reference
DW1116-5	GLASS-VOLVO 5PK	510013803
DW1117-5	GLASS-VOLVO 5PK	510013802
DW1308-5	GLASS-VOLVO 5PK	85102569, 1619263
DW1525-5	GLASS-VOLVO 5PK	8084220, 85108635
DW863-5	GLASS-VOLVO 5PK	3080293
DW864-5	GLASS-VOLVO 5PK	3080292
DW865-5	GLASS-VOLVO 5PK	3080291
DW866-5	GLASS-VOLVO 5PK	3080290
DW2433-10	GLASS-VOLVO VN SERIES W/LDWS BRKT 10PK	82797495
DW2433-25	GLASS-VOLVO VN SERIES W/LDWS BRKT 25PK	82797495
GB48205-5	GLASS-WARD 5PK	413287000
GB48204-5	GLASS-WAYNE 5PK	659733
DW966-5	GLASS-WESTERN STAR 5PK	51001-3204
DW1441-5	GLASS-WESTERN STAR CONV CAB 2001 & UP LH 5PK	51001-3428
DW1440-5	GLASS-WESTERN STAR CONV CAB 2001 & UP RH 5PK	51001-3429
DW1279-5	GLASS-WESTERN STAR CONV CAB 96-2000 LH 5PK	51001-3418
DW1278-5	GLASS-WESTERN STAR CONV CAB 96-2000 RH 5PK	51001-3419
DW965-5	GLASS-WHITE 5PK	51001-3203
DW1882-20	GLASS-WINDSHIELD 20PK	N/A
DW1882-5	GLASS-WINDSHIELD 5PK	N/A
DW2039-20	GLASS-WINDSHIELD ONE PC 579/567 20/PKG	R44-6076, R44-6085, R44-6090, R44-6091
DW2039-5	GLASS-WINDSHIELD ONE PC 579/567 5/PK	R44-6076, R44-6085, R44-6090, R44-6091
DW2038-20	GLASS-WINDSHIELD ONE PC T680/T880 20/PKG	R44-6074, R44-6086, R44-6097
DW2038-5	GLASS-WINDSHIELD ONE PC T680/T880 5/PK	R44-6074, R44-6086, R44-6097
FW00758-20	HINO RANGER CABOVER TRUCK Y630 89 20PK	N/A
FW00758-5	HINO RANGER CABOVER TRUCK Y630 89 5PK	N/A
FW00759-20	HINO RANGER CABOVER TRUCK Y633 89 (WIDE) 20PK	N/A
FW00759-5	HINO RANGER CABOVER TRUCK Y633 89 (WIDE) 5PK	N/A
FW02521-20	HINO TRUCK RANGER PRO Y70 03 20PK	N/A
FW02521-5	HINO TRUCK RANGER PRO Y70 03 5PK	N/A
DW01231-5	ISUZU ELF CABOVER TRUCK NR93W 93 5 PK	N/A
DW01001-20	ISUZU ELF TRUCK 630W 8493 20PK	N/A



Part Number	Description	OE Cross Reference
DW01001-5	ISUZU ELF TRUCK 630W 8493 5PK	N/A
DW01002-20	ISUZU FORWARD CABOVER TRUCK FRR/FSR113 8 20PK	N/A
DW01301-20	ISUZU FORWARD CABOVER TRUCK FRR/FSR113 8 20PK	N/A
DW01002-5	ISUZU FORWARD CABOVER TRUCK FRR/FSR113 8 5PK	N/A
DW01301-5	ISUZU FORWARD CABOVER TRUCK FRR/FSR113 8 5PK	N/A
FW02013-20	MITSUBISHI CANTER TRUCK FE600 93 20PK	N/A
FW02013-5	MITSUBISHI CANTER TRUCK FE600 93 5PK	N/A
FW00628-20	MITSUBISHI FIGHTER TRUCK FK40/FK415 8492 20PK	N/A
FW00628-5	MITSUBISHI FIGHTER TRUCK FK40/FK415 8492 5PK	N/A
DW02025-10	PETERBILT TRUCKS 330/327/389 2012-2018 10PK	N/A
DW02025-5	PETERBILT TRUCKS 330/327/389 2012-2018 5PK	N/A
DW02573-5	VOLVO VN SERIES 2017- 5PK	N/A
DW02694-20	VOLVO VN SERIES CONVENTIONAL CAB 2018 20PK	N/A
DW02694-5	VOLVO VN SERIES CONVENTIONAL CAB 2018 5PK	N/A
DW02692-20	VOLVO VN SERIES CONVENTIONAL CAB 2019 20PK	N/A
DW02692-5	VOLVO VN SERIES CONVENTIONAL CAB 2019 5PK	N/A
DW02640-25	VOLVO VN SERIES CONVENTIONL CAB 2018- 25PK	N/A
DW02640-5	VOLVO VN SERIES CONVENTIONL CAB 2018- 5PK	N/A
DW1753-10	WINDSHIELD - THOMAS C2 SAFTLINER 10PK	N/A
DW1753-15	WINDSHIELD - THOMAS C2 SAFTLINER 15PK	N/A
DW2693-30	WINDSHIELD - VOLVO W/RAIN SENSOR MOUNT 30PK	N/A
DW2693-5	WINDSHIELD - VOLVO W/RAIN SENSOR MOUNT 5PK	N/A
DW2573-30	WINDSHIELD-VOLVO VN 2017&UP W/RAIN SNSR 30PK	N/A
DW2561-20	WINDSHLD 567/579 ENCAP W/LDWS BENDIX 20PK	R44-6092



TRP Window Regulators

The TRP brand offers great product value and quality with competitive pricing in the trucking industry. Quality conscious customers replace and maintain heavy duty window components using these durable TRP products. These affordable, rugged options are alternates to OEM products and are application specific.

- Replaces and maintains regulators with high-grade TRP products
- Power Regulators packaged and sold individually with motors
- Products operate at maximum efficiency
- Easy to install

TRP WINDOW REGULATORS

Part Number	Description	Application	OE Part Number
WNR011000-L	REGULATOR-WINDOW ELECT W/MOTOR LH KW	Kenworth	R21-1005
WNR011000-R	REGULATOR-WINDOW ELECT W/MOTOR RH KW	Kenworth	R21-1005R
WNR011001-L	REGULATOR-WINDOW ELECT W/MOTOR LH KW	Kenworth	R21-1010
WNR011001-R	REGULATOR-WINDOW ELECT W/MOTOR RH KW	Kenworth	R21-1010R
WNR021000-L	REGULATOR-WINDOW ELECT W/MOTOR LH PB	Peterbilt	R21-6011
WNR021000-R	REGULATOR-WINDOW ELECT W/MOTOR RH PB	Peterbilt	R21-6011R
WNR031001-L	REGULATOR-WINDOW ELECT W/MOTOR LH KW/PB	Kenworth/Peterbilt	R21-6013
WNR031001-R	REGULATOR-WINDOW ELECT W/MOTOR RH KW/PB	Kenworth/Peterbilt	R21-6013R
WNR041000-L	REGULATOR-WINDOW ELECT W/MOTOR LH FRTLNR	Freightliner	A1852044000
WNR041000-R	REGULATOR-WINDOW ELECT W/MOTOR RH FRTLNR	Freightliner	A1852044001
WNR041001-L	REGULATOR-WINDOW ELECT W/MOTOR LH FRTLNR	Freightliner	A1848952000
WNR041001-R	REGULATOR-WINDOW ELECT W/MOTOR RH FRTLNR	Freightliner	A1848952001
WNR051000-L	REGULATOR-WINDOW ELECT W/MOTOR LH INTL	International	3515112C92
WNR051000-R	REGULATOR-WINDOW ELECT W/MOTOR RH INTL	International	3515113C92



TRP DOOR AND WINDOW HANDLES



TRP Door and Window Handles

TRP introduces a wide range of all-makes door and window handles supported by application and cross-reference information. These offerings deliver great value and quality at competitive prices, providing affordable alternatives to industry OEM handles.

- Cover a variety of makes and models
- Black and Chrome handles available
- Proper fit, form and function ensured
- Packaged and sold individually

TRP DOOR AND WINDOW HANDLES

Part Number	Description	Model	Model/Year	OE Cross Reference
DRH011000L	HANDLE-DOOR Outside LH CHROME	Kenworth	T660 T600 1995-2006 / K100, W900 1981-2006	K294-194
DRH011000R	HANDLE-DOOR Outside RH CHROME	Kenworth	T660 T600 1995-2006 / K100, W900 1981-2006	K294-194R
DRH011001L	HANDLE-DOOR Inside LH CHROME	Kenworth	T400, T450, T600, T600A, T800, W900 1982-2005	K294-195
DRH011001R	HANDLE-DOOR Inside RH CHROME	Kenworth	T400, T450, T600, T600A, T800, W900 1982-2005	K294-195R
DRH011002L	HANDLE-DOOR TOOL Outside LH CHROME	Kenworth	T600 T800 W900 Sleeper And Compartments 2004-2015	K294-321
DRH011002R	HANDLE-DOOR TOOL Outside RH CHROME	Kenworth	T600 T800 W900 Sleeper And Compartments 2004-2015	K294-321R
DRH011003L	HANDLE-DOOR Outside LH CHROME	Kenworth	T-Series 1995-2001	K294-411PAK
DRH011003R	HANDLE-DOOR Outside RH CHROME	Kenworth	T-Series 1995-2001	K294-411RPAK
DRH011004L	HANDLE-DOOR Inside LH BLACK	Kenworth	T-Series And W-Series 1995-2001	K294-426LPAK
DRH011004R	HANDLE-DOOR Inside RH BLACK	Kenworth	T-Series And W-Series 1995-2001	K294-426RPAK
DRH021000L	HANDLE-DOOR Outside LH CHROME	Peterbilt	Fits 349,353,359 (1100 Model Cab), Fits 378-379 Up To 2005 (1983-2005)	20-08179L
DRH021000R	HANDLE-DOOR Outside RH CHROME	Peterbilt	Fits 349,353,359 (1100 Model Cab), Fits 378-379 Up To 2005 (1983-2005)	20-08179R
DRH021001L	HANDLE-DOOR Inside LH BLACK	Peterbilt	349,353, 359, 377,378,379 1983-2005	20-13412L
DRH021001R	HANDLE-DOOR Inside RH BLACK	Peterbilt	349,353, 359, 377,378,379 1983-2005	20-13412R
DRH021002L	HANDLE-DOOR BAG Outside LH CHROME	Peterbilt	Sleeper And Accessory 1987-2005	29-03610L

TRP DOOR AND WINDOW HANDLES



Part Number	Description	Model	Model/Year	OE Cross Reference
DRH021002R	HANDLE-DOOR BAG Outside RH CHROME	Peterbilt	Sleeper And Accessory 1987-2005	29-03610R
DRH031000L	HANDLE-DOOR Outside LH BLACK HSG CHROME LEVER	Kenworth/Peterbilt	T270,T300,T370,T660,325.330,357,386,389 W/Daylight Door 2001-2016	R56-1025L
DRH031000R	HANDLE-DOOR Outside RH BLACK HSG CHROME LEVER	Kenworth/Peterbilt	T270,T300,T370,T660,325.330,357,386,389 W/Daylight Door 2001-2016	R56-1025R
DRH041000L	HANDLE-DOOR Outside CHROME LH	Freightliner	Classic Cab, FLD112 1997-2013	A18-35381-000
DRH041000R	HANDLE-DOOR Outside CHROME RH	Freightliner	Classic Cab, FLD112 1997-2013	A18-35381-001
DRH041001L	HANDLE-DOOR Outside CHROME LH	Freightliner	Columbia, Cascadia 2000-2011	A18-42228-000
DRH041001R	HANDLE-DOOR Outside CHROME RH	Freightliner	Columbia, Cascadia 2000-2011	A18-42228-001
DRH041002L	HANDLE-DOOR Outside CHROME LH	Freightliner	Columbia, Condor 1996-2011	A18-42228-002
DRH041002R	HANDLE-DOOR Outside CHROME RH	Freightliner	Columbia, Condor 1996-2011	A18-42228-003
DRH041003L	HANDLE-DOOR Outside W/O 30CM ROD BLACK LH	Freightliner	Condor And Columbia	A18-51913-008
DRH041003R	HANDLE-DOOR Outside W/O 30CM ROD BLACK RH	Freightliner	Condor And Columbia	A18-51913-009
DRH041004L	HANDLE-DOOR Outside BLACK LH	Freightliner	Cascadia, Business M2 08-16	A18-47729-002
DRH041004R	HANDLE-DOOR Outside BLACK RH	Freightliner	Cascadia, Business M2 08-16	A18-47729-003
DRH051000L	HANDLE-DOOR Inside (#10-24) LH ZINC BLACK	International	Truck 1984-2005	1649758C1, 02023003
DRH051000R	HANDLE-DOOR Inside (#10-24) RH ZINC BLACK	International	Truck 1984-2005	1649759C1, 02023008
DRH051001L	HANDLE-DOOR Inside (#10-24) LH ZINC CHROME	International	Truck 1984-2005	1649758C1, 02023003 - Chrome
DRH051001R	HANDLE-DOOR Inside (#10-24) RH ZINC CHROME	International	Truck 1984-2005	1649759C1, 02023008 -Chrome
DRH051002L	HANDLE-DOOR Inside LH BLACK	International	4300 IHC 08-C, Prostar 08-C , Durastar 10-C, 73/74/75/76/7700, 85/8600, CXT, MXT, RXT	2505424C1
DRH051002R	HANDLE-DOOR Inside RH BLACK	International	4300 IHC 08-C, Prostar 08-C , Durastar 10-C, 73/74/75/76/7700, 85/8600, CXT, MXT, RXT	2505425C1
DRH051003	HANDLE-DOOR Outside LONG LEG Zinc CHROME	International	1997-2008 (2000, 3000, 4000, 7000,8000,9000 Series)	3550930C91
DRH051004	HANDLE-DOOR Outside SHORT LEG Zinc CHROME	International	Truck 84-05, Dina 80, Famsa (Fits International 4700, 4900, 7100, 8100, 8200 And 8300 Series.)	3550931C91
DRH051005L	HANDLE-DOOR Outside BLACK LH INTERNATIONAL	Prostar	07-14, 3200 Comm BUS; 41/42/43/4400; 73/74/75/76/7700; 85/8600; CXT/MXT/RXT	2587515C1L



TRP DOOR AND WINDOW HANDLES

Part Number	Description	Model	Model/Year	OE Cross Reference
DRH051005R	HANDLE-DOOR Outside BLACK RH INTERNATIONAL	Prostar	07-14, 3200 Comm BUS; 41/42/43/4400; 73/74/75/76/7700; 85/8600; CXT/MXT/RXT	2587515C1R
DRH051006L	HANDLE-DOOR Outside BLACK W/CHROME LH INTERNATIONAL	Prostar	International 2014-07	3747731C1, 2511121C91
DRH051006R	HANDLE-DOOR Outside BLACK W/CHROME RH INTERNATIONAL	Prostar	4300 IHC 14-C	3747732C1, 3747733C1, 3747734C1, 2511122C91
DRH051007L	HANDLE-DOOR Outside BLACK W/CHROME LH INTERNATIONAL	Prostar	07-14, 3200 Comm BUS; 41/42/43/4400; 73/74/75/76/7700; 85/8600; CXT/MXT/RXT	2594003C1
DRH051007R	HANDLE-DOOR Outside BLACK W/CHROME RH INTERNATIONAL	Prostar	07-14, 3200 Comm BUS; 41/42/43/4400; 73/74/75/76/7700; 85/8600; CXT/MXT/RXT	2594006C1
DRH061000L	HANDLE-DOOR Outside BLACK LH	Volvo	FM2012/FH2012 (US For VN & VNL & VT Models)	20398466
DRH061000R	HANDLE-DOOR Outside BLACK RH	Volvo	FM2012/FH2012 (US For VN & VNL & VT Models)	20398467
DRH061001L	HANDLE-DOOR Outside BLACK W/CHROME LH	Volvo	FM2012/FH2012 (US For VN & VNL & VT Models)	20398466, 20398466-MA
DRH061001R	HANDLE-DOOR Outside BLACK W/CHROME RH	Volvo	FM2012/FH2012 (US For VN & VNL & VT Models)	20398467, 20398467-MA, 1063327
DRH061002	HANDLE-DOOR Inside BASE RH	Volvo	T300, T800, W900, T2000, T700 1993-2015 & 387, 587 1999-2011	20379593
DRH061002L	HANDLE-DOOR Inside BASE LH	Volvo	FM2012/FH2012 (US For VN & VNL & VT Models)	1063327
DRH061002R	HANDLE-DOOR Inside BASE LH	Volvo	FM2012/FH2012 (US For VN & VNL & VT Models)	1063328
WNH031000	HANDLE-WINDOW BLACK	Kenworth/Peterbilt	M2 2002-2015	KP20-16677, K294-418
WNH041000	HANDLE-WINDOW BLACK	Freightliner	Acterra 5500, 6500, 7500, 8500 1990-2009/2009-90	FW80XDV, A18-43563-000
WNH041001	HANDLE-WINDOW BLACK	Freightliner	FLD Classic 2003-2009, 1991-1996	F37Z-1023342-A, A18-59828-000
WNH041002	HANDLE-WINDOW BLACK	Freightliner	FLD Classic 2003-2009, 1991-1996	A18-18557-000



TRP Exhaust

TRP offers a wide selection of premium exhaust stacks in chrome that come in a variety of lengths. These exhaust products are made of high-quality materials, are plated to industry specifications, and are very durable. With many types of configurations to choose from, you're sure to find a configuration that will fit your needs.

- Meets industry standards
- Precision engineered to provide a tight seal and fit

TRP EXHAUST STACKS

Part Number	Description	OE Cross Reference
EP50S260C	Exhaust Stack, Straight (5"X60"), Chrome OP	K180-1179-60CP
EP50CS254C	Exhaust Stack, Curved (5"X54"), Chrome OD	K180-1096-54CP, 89997C-TP
EP50CS218C	Exhaust Stack, Curved (5"X18"), Chrome OD	K180-1096-18CP

Consistent OEM Quality:

TRP Exhaust stacks meet or exceed OEM specifications. They are precision engineered to provide a tight seal and precise fit.

See your dealer for additional applications not listed above.



OE QUALITY TANKS

- Peterbilt Fuel Tanks are certified to meet all federal safety requirements
- Peterbilt Fuel Tanks undergo rigorous drop tests to ensure safety



PETERBILT FUEL TANKS

PART#	DESCRIPTION	DIAMETER	LENGTH (IN)	CAPACITY (GAL)	SENDING UNIT (IN)	HEATING FILTER	FILLER	OE CROSS REFERENCE
RPFT001	Peterbilt Fuel Tank	26"	41"	80	B	Unheated	16.53	11-04813-037B042U
RPFT002	Peterbilt Fuel Tank	26"	50.5"	100	B	Unheated	21.65	11-04821-050B055U
RPFT003	Peterbilt Fuel Tank	26"	50.5"	100	T	Unheated	21.65	11-04821-050T055U
RPFT004	Peterbilt Fuel Tank	26"	66.8"	135	B	Unheated	4.33	11-04833-072B011U
RPFT005	Peterbilt Fuel Tank	26"	66.8"	135	B	Unheated	55.51	11-04833-071B141U
RPFT006	Peterbilt Fuel Tank	26"	73.8"	150	B	Unheated	62.6	11-04836-076B159U
RPFT007	Peterbilt Fuel Tank	26"	73.8"	150	T	Unheated	62.6	11-04836-076T159U
RPFT008	Peterbilt Fuel Tank	26"	50.5"	100	B	Unheated	4.33	11-04821-052B011U
RPFT009	Peterbilt Fuel Tank	26"	50.5"	100	T	Unheated	4.33	11-04821-051T011U
RPFT010	Peterbilt Fuel Tank	26"	73.8"	150	B	Unheated	33.07	11-04836-079B084U
RPFT011	Peterbilt Fuel Tank	26"	73.8"	150	T	Unheated	33.7	11-04836-079T084U

SPECIAL NOTE:

No portion of the filler, boss or multi-boss should be closer than 6 inches fore or aft of the centerline of any exhaust elbow. All measurements are from the left weld line as illustrated below.

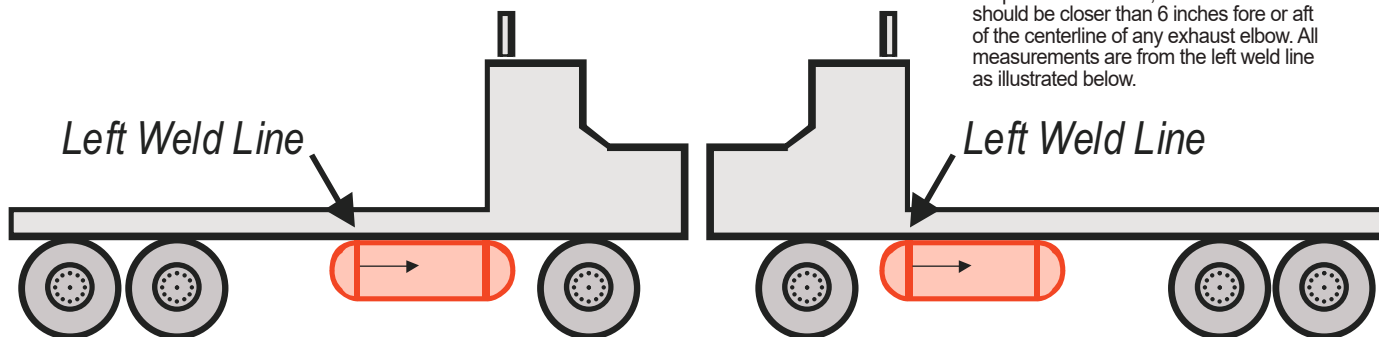



TRP Fuel Tank

The TRP all-makes fuel tank program offers a cost-effective alternative to repairing or replacing your tank with a lower quality will fit tank. Each tank is manufactured using robotic processes to ensure that they meet stringent federal safety requirements.

- Made from .125" OEM Grade Aluminum for maximum weight to strength ratio
- Available in 23", 24.5", 25", and 26" diameters to fit all major OEM applications
- Filler neck locations: right, center, and left, for a variety of fit and functions options
- 50-to-150-gallon sizes to ensure multiple sizes for each diameter
- Acid etch finish for consistent and uniform finish
- Fuel cap, vent, and standard fittings offer convenience and reduced cost
- Freight included in price compared to other suppliers where freight costs extra
- 2-year Nationwide warranty means service is available at 600+ locations

TRP FUEL TANKS

For help with your TRP fuel tank installation reach out to our technical team at SUPPORT@TRPPARTS.COM

Part Number	Model	Dia. (D) in/cm	Capacity Gal /Liters	Overall Length (C) in/cm	Fill Neck (A) in/cm	Draw Return Cluster in/cm	Sending Unit (B) in/cm	Vent in/cm	Filler Neck Location	Tank Loc
FT0103101	Freightliner	23/58	100/379	61/154	30/77	30/77	27/70	32/82	Center	LH
FT0103102	Freightliner	23/58	100/379	61/154	30/77	30/77	27/70	32/82	Center	RH
FT0103103	Freightliner	23/58	100/379	61/154	20/51	20/51	17/43	22/56	Right	RH
FT0103104	Freightliner	23/58	100/379	61/154	20/51	20/51	17/43	22/56	Left	LH
FT0103305	Peterbilt	23/58	100/379	61/154	30/77	30/77	30/77	30/77	Center	RH
FT0103305	Peterbilt	23/58	100/379	61/154	30/77	30/77	30/77	30/77	Center	LH
FT0103306	Peterbilt	23/58	100/379	61/154	53/134	30/77	30/77	30/77	Right	LH
FT0103306	Peterbilt	23/58	100/379	61/154	8/20	30/77	30/77	30/77	Right	RH
FT0103307	Peterbilt	23/58	100/379	61/154	53/134	30/77	30/77	30/77	Left	RH
FT0103307	Peterbilt	23/58	100/379	61/154	8/20	30/77	30/77	30/77	Left	LH
FT0103601	Sterling	23/58	100/379	61/154	30/77	30/77	27/70	32/82	Center	LH
FT0103602	Sterling	23/58	100/379	61/154	30/77	30/77	27/70	32/82	Center	RH
FT0103603	Sterling	23/58	100/379	61/154	22/56	22/56	19/49	24/61	Right	RH
FT0103604	Sterling	23/58	100/379	61/154	22/56	22/56	19/49	24/61	Left	LH
FT0105101	Freightliner	23/58	120/454	73/185	36/92	36/92	33/85	38/98	Center	LH

Note: See dealer for specific tank measurements. If the part number ends in LH or RH, then the tank is specifically for either the left hand (LH) or right hand (RH) side, respectively. LH = Driver's Side RH = Passenger Side. If the part number ends in LF or RF then the tank can be located on either side of the truck. LF for Driver's Side (the A LH dimension would be toward the front of the truck) RF for Passenger's Side (the A RH dimension would be toward the front of the truck) The overall length measurement (C dimension) is from end cap to end cap.



TRP FUEL TANKS

Part Number	Model	Dia. (D) in/cm	Capacity Gal /Liters	Overall Length (C) in/cm	Fill Neck (A) in/cm	Draw Return Cluster in/cm	Sending Unit (B) in/cm	Vent in/cm	Filler Neck Location	Tank Loc
FT0105102	Freightliner	23/58	120/454	73/185	36/92	36/92	33/85	38/98	Center	RH
FT0105103	Freightliner	23/58	120/454	73/185	20/51	20/51	17/43	22/56	Right	RH
FT0105104	Freightliner	23/58	120/454	73/185	20/51	20/51	17/43	22/56	Left	LH
FT0105801	Western Star	23/58	120/454	73/185	36/92	36/92	33/85	38/98	Center	LH
FT0105802	Western Star	23/58	120/454	73/185	36/92	36/92	33/85	38/98	Center	RH
FT0105803	Western Star	23/58	120/454	73/185	52/132	52/132	49/124	54/137	Left	RH
FT0105804	Western Star	23/58	120/454	73/185	52/132	52/132	49/124	54/137	Right	LH
FT0108101	Freightliner	23/58	140/530	85/215	42/108	42/108	39/100	44/113	Center	LH
FT0108102	Freightliner	23/58	140/530	85/215	42/108	42/108	39/100	44/113	Center	RH
FT0108103	Freightliner	23/58	140/530	85/215	20/51	20/51	17/43	22/56	Right	RH
FT0108104	Freightliner	23/58	140/530	85/215	20/51	20/51	17/43	22/56	Left	LH
FT0202205	Kenworth	24.5/62	75/284	40/103	20/51	20/51	20/51	23/59	Center	RH
FT0202205	Kenworth	24.5/62	75/284	40/103	20/51	20/51	20/51	23/59	Center	LH
FT0202206	Kenworth	24.5/62	75/284	40/103	8/19	23/57	23/57	17/44	Right	RH
FT0202206	Kenworth	24.5/62	75/284	40/103	33/84	18/45	18/45	23/59	Right	LH
FT0202207	Kenworth	24.5/62	75/284	40/103	8/19	23/57	23/57	17/44	Left	LH
FT0202207	Kenworth	24.5/62	75/284	40/103	33/84	18/45	18/45	23/59	Left	RH
FT0203205	Kenworth	24.5/62	100/379	54/136	27/68	27/68	27/68	31/78	Center	RH
FT0203205	Kenworth	24.5/62	100/379	54/136	27/68	27/68	27/68	31/78	Center	LH
FT0203206	Kenworth	24.5/62	100/379	54/136	44/113	25/63	25/63	31/78	Right	LH
FT0203206	Kenworth	24.5/62	100/379	54/136	9/24	29/74	29/74	23/58	Right	RH
FT0203207	Kenworth	24.5/62	100/379	54/136	44/113	25/63	25/63	31/78	Left	RH
FT0203207	Kenworth	24.5/62	100/379	54/136	9/24	29/74	29/74	23/58	Left	LH
FT0205205	Kenworth	24.5/62	120/454	64/163	32/82	32/82	32/82	36/92	Center	RH
FT0205205	Kenworth	24.5/62	120/454	64/163	32/82	32/82	32/82	36/92	Center	LH
FT0205206	Kenworth	24.5/62	120/454	64/163	9/24	34/87	34/87	28/72	Right	RH
FT0205206	Kenworth	24.5/62	120/454	64/163	55/140	30/76	30/76	36/92	Right	LH
FT0205207	Kenworth	24.5/62	120/454	64/163	9/24	34/87	34/87	28/72	Left	LH
FT0205207	Kenworth	24.5/62	120/454	64/163	55/140	30/76	30/76	36/92	Left	RH
FT0209205	Kenworth	24.5/62	150/568	80/203	40/102	40/102	40/102	46/118	Center	RH

Part Number	Model	Dia. (D) in/cm	Capacity Gal /Liters	Overall Length (C) in/cm	Fill Neck (A) in/cm	Draw Return Cluster in/cm	Sending Unit (B) in/cm	Vent in/cm	Filler Neck Location	Tank Loc
FT0209205	Kenworth	24.5/62	150/568	80/203	40/102	40/102	40/102	46/118	Center	LH
FT0209206	Kenworth	24.5/62	150/568	80/203	69/175	54/137	54/137	47/119	Right	LH
FT0209206	Kenworth	24.5/62	150/568	80/203	11/28	26/67	26/67	33/84	Right	RH
FT0209207	Kenworth	24.5/62	150/568	80/203	69/175	54/137	54/137	47/119	Left	RH
FT0209207	Kenworth	24.5/62	150/568	80/203	11/28	26/67	26/67	33/84	Left	LH
FT0301405	Mack	25/64	50/189	26/67	13/33	11/28	13/33	13/33	Center	RH
FT0301405	Mack	25/64	50/189	26/67	13/33	11/28	13/33	13/33	Center	LH
FT0301406	Mack	25/64	50/189	26/67	13/32	13/32	13/32	13/32	Right	RH
FT0301406	Mack	25/64	50/189	26/67	14/34	14/34	14/34	14/34	Right	LH
FT0301407	Mack	25/64	50/189	26/67	13/32	13/32	13/32	13/32	Left	LH
FT0301407	Mack	25/64	50/189	26/67	14/34	14/34	14/34	14/34	Left	RH
FT0302405	Mack	25/64	75/284	39/99	19/49	19/49	19/49	19/49	Center	RH
FT0302405	Mack	25/64	75/284	39/99	19/49	19/49	19/49	19/49	Center	LH
FT0302406	Mack	25/64	75/284	39/99	25/64	25/64	25/64	25/64	Left	RH
FT0302406	Mack	25/64	75/284	39/99	14/34	14/34	14/34	14/34	Left	LH
FT0302407	Mack	25/64	75/284	39/99	25/64	25/64	25/64	25/64	Right	LH
FT0302407	Mack	25/64	75/284	39/99	14/34	14/34	14/34	14/34	Right	RH
FT0304405	Mack	25/64	110/416	57/144	28/72	28/72	28/72	28/72	Center	RH
FT0304405	Mack	25/64	110/416	57/144	28/72	28/72	28/72	28/72	Center	LH
FT0304406	Mack	25/64	110/416	57/144	43/109	43/109	43/109	43/109	Left	RH
FT0304406	Mack	25/64	110/416	57/144	14/34	14/34	14/34	14/34	Left	LH
FT0304407	Mack	25/64	110/416	57/144	43/109	43/109	43/109	43/109	Right	LH
FT0304407	Mack	25/64	110/416	57/144	14/34	14/34	14/34	14/34	Right	RH
FT0403503	International	26/66	100/379	48/122	24/62	15/39	28/72	24/60	Right	RH
FT0403504	International	26/66	100/379	48/122	24/60	15/39	20/50	24/60	Left	LH
FT0404305	Peterbilt	26/66	110/416	53/136	27/68	27/68	27/68	27/68	Center	RH
FT0404305	Peterbilt	26/66	110/416	53/136	27/68	27/68	27/68	27/68	Center	LH
FT0404306	Peterbilt	26/66	110/416	53/136	46/116	27/68	27/68	27/68	Left	RH
FT0404306	Peterbilt	26/66	110/416	53/136	8/20	27/68	27/68	27/68	Left	LH
FT0404307	Peterbilt	26/66	110/416	53/136	46/116	27/68	27/68	27/68	Right	LH
FT0404307	Peterbilt	26/66	110/416	53/136	8/20	27/68	27/68	27/68	Right	RH



TRP FUEL TANKS

Part Number	Model	Dia. (D) in/cm	Capacity Gal /Liters	Overall Length (C) in/cm	Fill Neck (A) in/cm	Draw Return Cluster in/cm	Sending Unit (B) in/cm	Vent in/cm	Filler Neck Location	Tank Loc
FT0406503	International	26/66	125/473	60/151	36/91	15/39	40/101	24/60	Right	RH
FT0406504	International	26/66	125/473	60/151	24/60	15/39	20/50	24/60	Left	LH
FT0407305	Peterbilt	26/66	135/511	64/163	32/82	32/82	32/82	32/82	Center	RH
FT0407305	Peterbilt	26/66	135/511	64/163	32/82	32/82	32/82	32/82	Center	LH
FT0407306	Peterbilt	26/66	135/511	64/163	56/143	32/82	32/82	32/82	Left	RH
FT0407306	Peterbilt	26/66	135/511	64/163	8/20	32/82	32/82	32/82	Left	LH
FT0407307	Peterbilt	26/66	135/511	64/163	56/143	32/82	32/82	32/82	Right	LH
FT0407307	Peterbilt	26/66	135/511	64/163	8/20	32/82	32/82	32/82	Right	RH
FT0407705	Volvo	26/66	135/511	64/163	32/82	30/76	32/82	32/82	Center	RH
FT0407705	Volvo	26/66	135/511	64/163	32/82	30/76	32/82	32/82	Center	LH
FT0407706	Volvo	26/66	135/511	64/163	54/138	54/138	54/138	54/138	Left	RH
FT0407706	Volvo	26/66	135/511	64/163	10/25	10/25	10/25	10/25	Left	LH
FT0407707	Volvo	26/66	135/511	64/163	54/138	54/138	54/138	54/138	Right	LH
FT0407707	Volvo	26/66	135/511	64/163	10/25	10/25	10/25	10/25	Right	RH
FT0409305	Peterbilt	26/66	150/568	71/181	36/90	36/90	36/90	36/90	Center	RH
FT0409305	Peterbilt	26/66	150/568	71/181	36/90	36/90	36/90	36/90	Center	LH
FT0409306	Peterbilt	26/66	150/568	71/181	63/161	36/90	36/90	36/90	Left	RH
FT0409306	Peterbilt	26/66	150/568	71/181	8/20	36/90	36/90	36/90	Left	LH
FT0409307	Peterbilt	26/66	150/568	71/181	63/161	36/90	36/90	36/90	Right	LH
FT0409307	Peterbilt	26/66	150/568	71/181	8/20	36/90	36/90	36/90	Right	RH
FT0409503	International	26/66	150/568	71/181	48/121	15/39	52/131	24/60	Right	RH
FT0409504	International	26/66	150/568	71/181	24/60	15/39	20/50	24/60	Left	LH
FT0409705	Volvo	26/66	150/568	71/181	36/90	33/85	36/90	36/90	Center	RH
FT0409705	Volvo	26/66	150/568	71/181	36/90	33/85	36/90	36/90	Center	LH
FT0409706	Volvo	26/66	150/568	71/181	61/156	61/156	61/156	61/156	Left	RH
FT0409706	Volvo	26/66	150/568	71/181	10/25	10/25	10/25	10/25	Left	LH
FT0409707	Volvo	26/66	150/568	71/181	61/156	61/156	61/156	61/156	Right	LH
FT0409707	Volvo	26/66	150/568	71/181	10/25	10/25	10/25	10/25	Right	RH



FTC003L



FTC003



FTC001

TRP Fuel Tank Caps

TRP Fuel Tank Caps are a durable, high-quality replacement for OE Fuel Tank Caps. Fuel Tank Caps are used to seal off the fuel tank, preventing liquid fuel or vapor from escaping the system. The TRP Fuel Tanks cover a variety of heavy and medium duty applications and offer both locking and non-locking cap options.

Features and Benefits

- Manufactured with excellent thread engagement between cap and filler necks
- Designed for high-grade performance both on and off the road
- Two keys provided with locking cap

TRP FUEL CAPS

Part Number	Description	Application	OE Cross Reference
FTC001	CAP-FUEL 3"- 8 NPSF NON-LOCKING	Freightliner	03-37017-000, 03-34466-000
FTC001L	CAP-FUEL 3"- 8 NPSF LOCKING	Freightliner	03-37017-002, 03-34466-002
FTC002	CAP-FUEL LEVER STYLE NON-LOCKING	Peterbilt	11-04859-100, 11-04859-150
FTC002L	CAP-FUEL LEVER STYLE LOCKING	Peterbilt	11-04859-200, 11-04859-250
FTC003	CAP-FUEL 3"- 5.5 NON-LOCKING	Freightliner, Kenworth	N/A
FTC003L	CAP-FUEL 3"- 5.5 LOCKING	Freightliner, Kenworth	A03-12927-6, K071-385-1,2,3,4, K071-421-1,-2,-3,-4
FTC004	CAP-FUEL 4"- 8 NPSF NON-LOCKING	International	508010C91
FTC004L	CAP-FUEL 4"- 8 NPSF LOCKING	International	N/A
FTC005	CAP-FUEL 2"- 11.5 NPSF NON-LOCKING	International	3548221C1, 576746C91, 576746C92
FTC006	CAP-FUEL 3"- 8 NPSL NON-LOCKING	Freightliner, Western Star, Kenworth, International	A03-15682-4, 43301-3401, 249-2B, 2040848C91, 3559312C1
FTC006L	CAP-FUEL 3"- 8 NPSL LOCKING	Freightliner, Western Star, Kenworth, International	A03-15682-6, 249-4B



TRP QUARTER FENDERS



QT00101



QT00071



QT00213

TRP Quarter Fenders

TRP Quarter Fenders have a proven reputation for a long-lasting bright appearance and exceptional durability. These quarter fenders provide long-term corrosion resistance because the stainless surface does not pit, crack or face despite the inevitable stone impact and other rough treatment trucks encounter in heavy duty service. This superior durability allows for an extended warranty weight savings.

- 18-gauge formed metal provides greater strength
- 25" fender shield width enhances spray suppression and redirection

TRP QUARTER FENDERS

Part Number	Description	OE Cross Reference
QT00071	Fender-Quarter Braceless LH/RH	K127-716-4, K127-716-4R, A35-6024, A35-6024R, 82277222, 22803696, 22883043, 4031076C91, 4031077C91
QT00081	Fender-Quarter Braceless LH	K127-716-4, A35-6024, 4031076C91
QT00091	Fender-Quarter Braceless RH	K127-716-4R, A35-6024R, 4031077C91
QT00101	Fender-Quarter Full Brace	N/A
QT00111	Fender-Quarter Full Brace	N/A
QT00131	Fender-Quarter Half Brace	N/A
QT00171	Fender-Quarter Low Mount	N/A
QT00213	Fender-Quarter Xtrmwthr K	K127-716-6, K127-716-6R, K127-716-5, K127-716-5R, 18-03118-003, 18-03118-001, 22803692, 20703016, 20562262, 4105080C1, FLT1900BRPL, LT1900BRPR
QT00223	Fender-Quarter Xtrmwthr K LH	K127-716-6, K127-716-5, FLT1900BRPL
QT00233	Fender-Quarter Xtrmwthr K RH	K127-716-6R, K127-716-5RL, FLT1900BRPR
QT00251	SS 31" Quarter Fender No Mount	N231-SS



HLK10000



TRB68250



TRK59040

TRP Rubber Components

Choosing Rubber:

Choosing rubber over polyurethane is preferable when flexibility, elasticity, and vibration absorption are crucial. Rubber's natural properties make it effective for applications where shock absorption, noise reduction, and a softer material are desired.

Choosing Polyurethane:

Polyurethane is preferred over rubber when higher durability, abrasion resistance, and load-bearing capabilities are required. Polyurethane materials often outperform rubber in terms of wear resistance and can withstand harsh environmental conditions.

TRP RUBBER COMPONENTS

Part Number	Description	OE Cross Reference
EB10.30X33	Rubber Bushing 10.3IDx330Dx32L 8/PKG (14-14656-4)	14-14656-4
HLK10000	Hood Latch (K147-107)	K147-107
HLK10350	Hood Latch Kit (23-13857 / L56-0001)	23-13857 / L56-0001
M174020	Hood Pin (K179-528)	K179-528
M174120	Radiator Mount (07-03286RUB)	07-03286RUB
SB800010	Torque Rod Bushing Chalmers (800010CS1)	800010CS1
TRB68200	Torque Rod Bushing Hendrickson (44695-000L)	44695-000L
TRB68250	Torque Rod Bushing (839310)	839310
TRK59040	Rebushing Kit (03AL2)	03AL2
TRK59050	Rebushing Kit (03AL1)	03AL1



Air Cleaners

Headlights

Fenders

Bumpers

Hoods

Hood Springs

**Charge Air
Cooler**

Fuel Tanks

Cooling

Condensers

Mirrors

**Rubber
Components**

Grilles

Handles

Windshields

Grille Parts

Exhaust

Distributed Exclusively by PACCAR Parts



ICRCCAPB03-24